

PFC Input Capacitors

Metallized Polypropylene film capacitors

PCMP 352

(MPP)

MKP BOXED CAPACITORS

Pitch 10.0/15.0mm

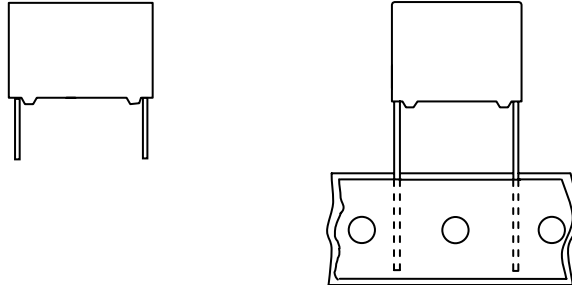

QUICK REFERENCE DATA

Capacitance range (E6 series)	0. 22 to 2.2 μ F
Capacitance tolerance	\pm 5%, \pm 10%
Rated voltage (DC)	450V
Climatic category	40/105/21
Temperature range	-40 $^{\circ}$ C ~ + 105 $^{\circ}$ C
Reference specification	IEC 60384-16
Potting & Encapsulation material	Qualified in accordance with UL94V-0

FEATURES <ul style="list-style-type: none"> . Low-noise . Self-healing properties . Low dissipation factor . Low ESR . Supplied loose in box . Miniature type of PCMP 372 	APPLICATIONS <ul style="list-style-type: none"> . PFC Input Capacitor for LCD/PDP TV power . PFC Input Capacitor for LED lamp power
--	--

- Please refer to caution and warning at <http://www.pilkor.co.kr/download/Introductions.pdf> before using these products.

PFC Input Capacitors
Metallized Polypropylene film capacitors

PCMP 352
(MPP)

Ordering Information

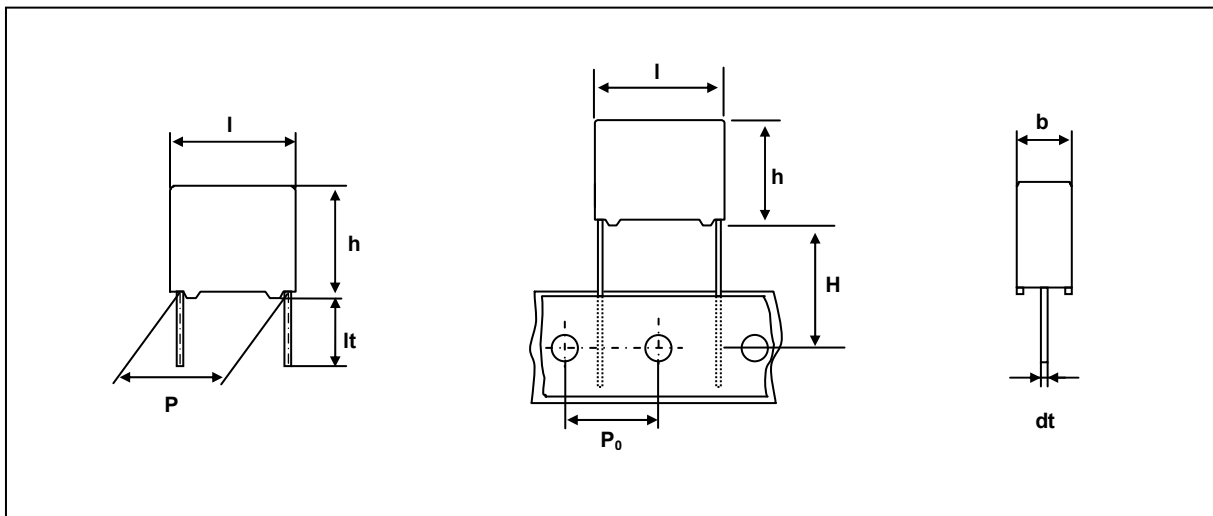

P	3	5	2	H	A	D	4	7	4	K	A	L	J
1				2		3	4		5	6	7		

1	
Code	Series Name
P352	PCMP 352

2	
Code	Voltage+Version
HA	450V

3	
Code	Original Pitch
D	10.0mm
F	15.0mm

4	
Code	Capacitance (example)
474	0.47uF
105	1.0uF

5	
Code	Capacitance Tolerance
J	± 5 %
K	± 10 %

6	
Code	Revision
A	Standard

7				Product(lmax)	
Code	Packing Method	Lead length & Height	Hole to hole (Po)	12.5	18.0
				Pitch(P)	
LJ	Loose in box	It= 5.0±1.0mm	-	10.0	15.0
LK	Loose in box	It=25.0±2.0mm	-	10.0	15.0
BH	Ammo packing	H=18.5mm*	12.7mm	10.0	15.0

*H(In-tape height) ; For detailed specifications refer to chapter PACKAGING.

Packaging Information

SMALLEST PACKING QUANTITIES (SPQ)	Loose in box	
	It = 5.0±1.0mm	It = 25.0±2.0mm
DIMENSIONS	SPQ	SPQ
4.0 X 10.0 X 12.5	2000	1200
5.0 X 11.0 X 12.5	1500	1000
6.0 X 12.0 X 12.5	1000	1000
5.0 X 11.0 X 18.0	1000	1000
6.0 X 12.0 X 18.0	1000	1000
7.0 X 13.5 X 18.0	1000	1000
8.5 X 15.0 X 18.0	1000	1000
10.0 X 16.5 X 18.0	1000	1000
11.0 X 18.5 X 18.0	1000	1000

PFC Input Capacitors

PCMP 352

Metallized Polypropylene film capacitors

(MPP)

 $V_{Rdc} = 450 \text{ V}$

Cap. (μF)	b x h x l (mm)	Mass (g)	CATALOGUE NUMBER	
			loose in box	
			lt= 5.0 \pm 1.0 mm	lt= 25.0 \pm 2.0 mm
			C – tol. \pm 10%	C – tol. \pm 10%
Pitch = 10.0 \pm 0.4 mm			dt = 0.6 + 0.06 / -0.05 mm	
0.22	4.0 x 10.0 x 12.5	0.8	P352HAD224KALJ	P352HAD224KALK
0.27	5.0 x 11.0 x 12.5	1.0	P352HAD274KALJ	P352HAD274KALK
0.33	5.0 x 11.0 x 12.5	1.0	P352HAD334KALJ	P352HAD334KALK
0.39	6.0 x 12.0 x 12.5	1.3	P352HAD394KALJ	P352HAD394KALK
0.47	6.0 x 12.0 x 12.5	1.3	P352HAD474KALJ	P352HAD474KALK
Pitch = 15.0 \pm 0.4 mm			dt = 0.8 + 0.08 / -0.05 mm	
0.47	5.0 x 11.0 x 18.0	1.4	P352HAF474KALJ	P352HAF474KALK
0.56	6.0 x 12.0 x 18.0	1.8	P352HAF564KALJ	P352HAF564KALK
0.68	6.0 x 12.0 x 18.0	1.8	P352HAF684KALJ	P352HAF684KALK
0.82	7.0 x 13.5 x 18.0	2.2	P352HAF824KALJ	P352HAF824KALK
1.0	7.0 x 13.5 x 18.0	2.2	P352HAF105KALJ	P352HAF105KALK
1.2	8.5 x 15.0 x 18.0	2.9	P352HAF125KALJ	P352HAF125KALK
1.5	8.5 x 15.0 x 18.0	2.9	P352HAF155KALJ	P352HAF155KALK
1.8	10.0 x 16.5 x 18.0	3.6	P352HAF185KALJ	P352HAF185KALK
2.2	11.0 x 18.5 x 18.0	4.4	P352HAF225KALJ	P352HAF225KALK

MOUNTING**NORMAL USE**

The capacitors are designed for mounting on printed-circuit boards. The capacitors packed in bandoliers are designed for mounting on printed-circuit boards by means of automatic insertion machines.

SPECIFIC METHOD OF MOUNTING TO WITHSTAND VIBRATION AND SHOCK

- . For pitches of 15 mm the capacitors shall be mechanically fixed by the leads
- . For larger pitches the capacitors shall be mounted in the same way and the body clamped.

SPACE REQUIREMENTS ON PRINTED-CIRCUIT BOARD

The maximum length and width of film capacitors are shown in the following drawing ;

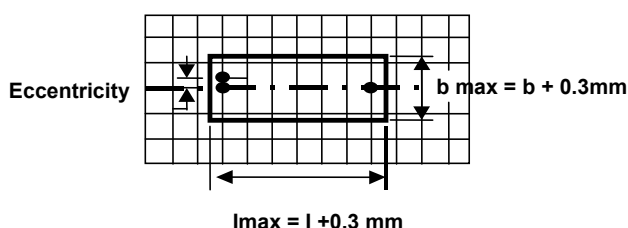

- Eccentricity as in drawing.
The maximum eccentricity is smaller than or equal to the lead diameter of the product concerned.
- Product height with seating plane as given by IEC 60717 as reference : $h_{\max} \leq h + 0.3\text{mm}$

STORAGE TEMPERATURE

. Storage temperature : $T_{\text{stg}} = -25$ to $+40^\circ\text{C}$ with RH maximum 80% without condensation.

RATINGS AND CHARACTERISTICS

Unless otherwise specified all electrical values apply at an ambient temperature of $23 \pm 1^\circ\text{C}$, an atmospheric pressure of 86 to 106kPa and a relative humidity of $50 \pm 2\%$.

For reference testing a conditioning period shall be applied of 96 ± 4 hours by heating the products in a circulating air oven at the rated temperature and a relative humidity not exceeding 20%.

CHARACTERISTICS● **Test Voltage**

- Cut off current 10mA / rise time 100V/sec.
- Test Voltage (between lead and lead) : $1.6 \times V_{Rdc}$, 1min.
- Test Voltage (between leads and case) : $2840 V_{dc}$, 1min.

● **Capacitance**

- . Capacitance : Within specified tolerance range when sine wave AC is applied at 1kHz ± 200 Hz and $5V_{rms}$

● **Dissipation Factor(DF)**

- . Dissipation factor: When sine wave AC is applied at 10kHz and $\leq 1 V_{rms}$, $DF < 20 \times 10^{-4}$

● **Insulation Resistance**

- . The insulation resistance is measured for 1min. ± 5 s, at 100V for $V_{Rdc} < 500$ V, at 500V for $V_{Rdc} \geq 500$ V

Rated voltage	Minimum RC	Minimum Insulation Resistance
	Capacitance > 0.33uF	Capacitance \leq 0.33uF
450V	> 10,000s	> 30G Ω

(R = insulation resistance between the terminations [Ω], C= capacitance[Farad])

● **Rated Voltage Pulse Load Slope(dV/dt)_R**

- . For values see specific reference data. IF the pulse voltage is lower than the rated voltage, values of the specific reference data must be multiplied by V_{Rdc} and divided by the applied voltage.

Rated voltage	MAXIMUM RATED VOLTAGE PULSE SLOPE (V/ μ s)	
	P = 10.0 mm	P = 15.0 mm
450V	47.5	47.5

THE GRAPHS OF CHARACTERISTICS

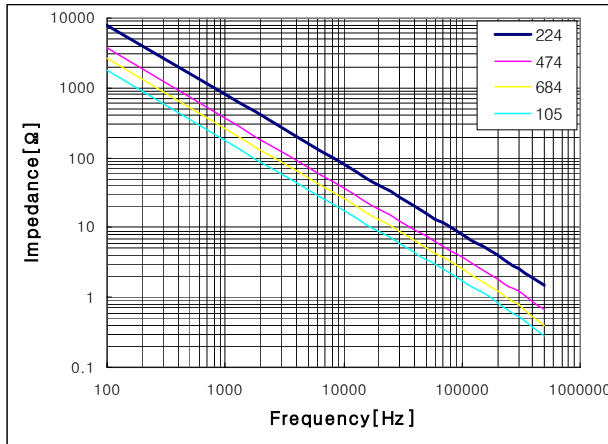

Impedance as a function of frequency
at $T_{amb.} \leq 85^{\circ}C$ for original pitch 10.0mm

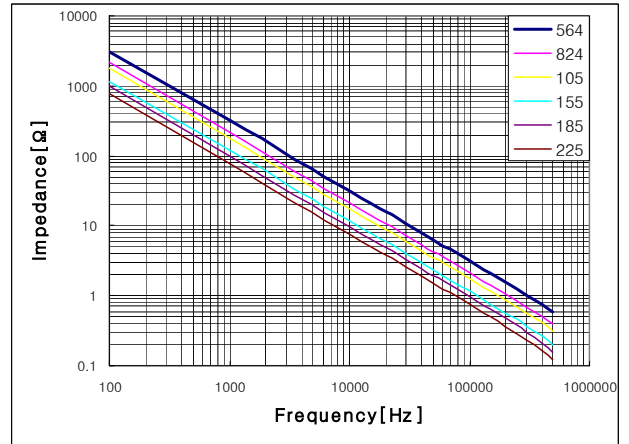

Impedance as a function of frequency
at $T_{amb.} \leq 85^{\circ}C$ for original pitch 15.0mm

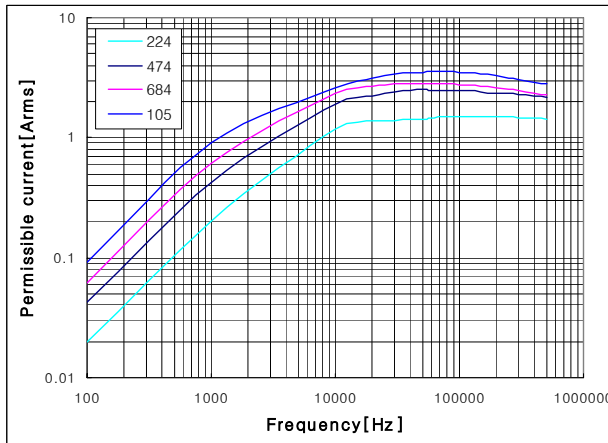

Permissible current as a function of frequency
at $T_{amb.} \leq 85^{\circ}C$ for original pitch 10.0mm

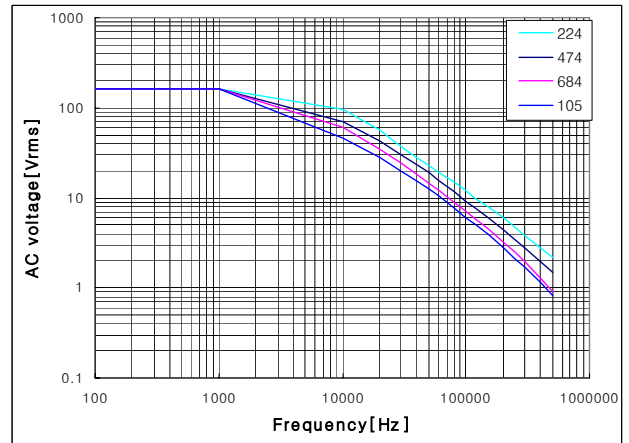

AC voltage as a function of frequency
at $T_{amb.} \leq 85^{\circ}C$ for original pitch 10.0mm

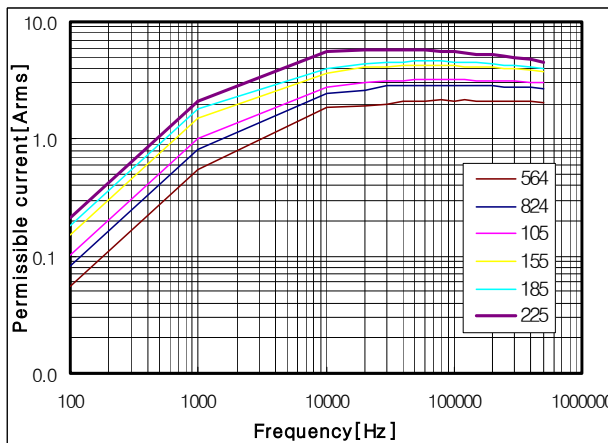

Permissible current as a function of frequency
at $T_{amb.} \leq 85^{\circ}C$ for original pitch 15.0mm

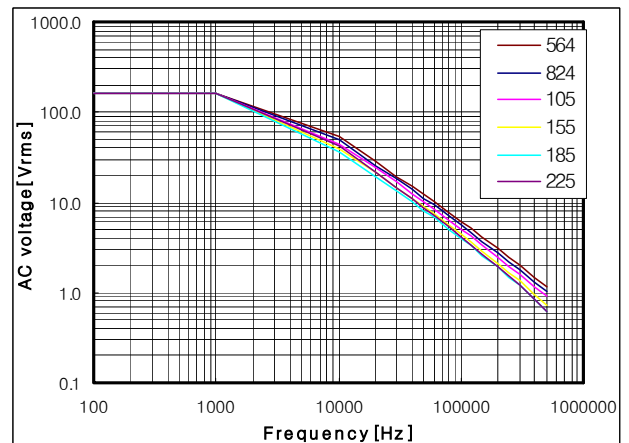

AC voltage as a function of frequency
at $T_{amb.} \leq 85^{\circ}C$ for original pitch 15.0mm

- **Permissible current to temperature**

When operating in the range of $T_{amb.}$ ($85^{\circ}\text{C} \sim 105^{\circ}\text{C}$) with waveform, the value for characteristic of permissible current to frequency shown in Fig. shall be derated 2.25% at each 1°C .

- **Self heating temperature**

. Maximum allowable rise is 7°C under 85°C .

- **Maximum permissible continuous voltage vs temperature [$^{\circ}\text{C}$]**

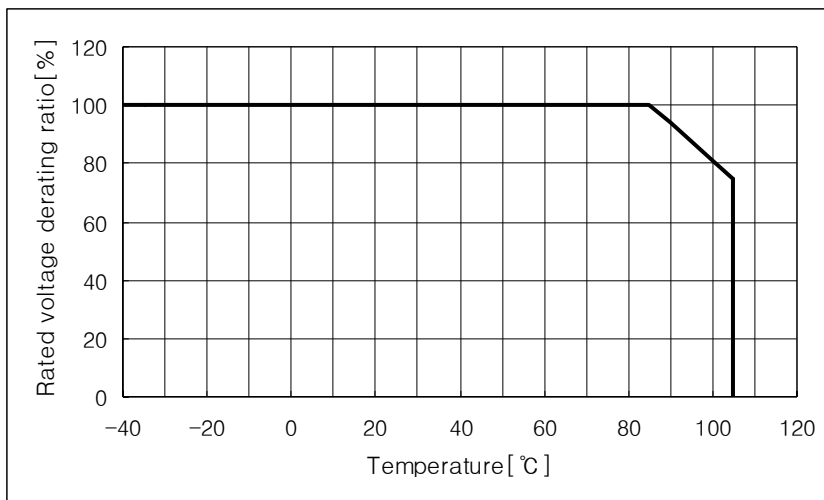

PRODUCT MARKING

The capacitors are marked with the following informations :

- . Rated capacitance in code according to IEC 60062 (470n ; 470nF)
- . Tolerance on rated capacitance (J : $\pm 5\%$, K : $\pm 10\%$)
- . Rated DC voltage (450V)
- . Manufacturer's mark (PILKOR)
- . Manufacturer's type designation (352)
- . Code for dielectric material (MKP)
- . Date code number (WK....)

Example of marking

Pitch = 10.0mm

470n K 450V 352 MKP PILKOR

Marking on the side

Pitch = 15.0mm

470n K 450V 352 MKP

Marking on the top

PILKOR WK....

Marking on the side