

DC HIGH VOLTAGE EV RELAY

EVR200



▶ FEATURES

- High-voltage, high-current control capable**
With ceramic seal structure, the contact chamber filled with hydrogen mixed educing gas, combined with magnetic blow-out. Voltage relay can cut off load voltage of 1000VDC.
- Compact Design & Low Operating Sound**
By using a capsule contact mechanism that is enclosed with hydrogen gas, ighcapacity cutoff is possible even with a tiny contact gap. There is little operating sound, which does not change even when large currents are cut off.
- High contact reliability ,High Safety**
Arc will not get out with design of that contacts are enclosed in a sealed apsule,Long service life.

▶ COIL SPECIFICATION

ITEM		MAX. STARTING CURRENT(A)	MAX. IMPACT TIME(ms)	NOMINAL OPERATING CURRENT(A)	PULL-IN VOLTAGE(V)	DROP-OUT VOLTAGE(V)	COIL POWER	MAX. ALLOWABLE VOLTAGE(V)
NOMINAL VOLTAGE								
DC	12 V	3A	120ms	0.35A	≤9VDC	≥1VDC	34W(0.1s) Keep 4W	16VDC
	24 V	1.5A	120ms	0.175A	≤18VDC	≥2VDC	34W(0.1s) Keep 4W	32VDC

▶ CONTACT RATINGS

ITEM	MODEL	Unipolar resistive load(L/R≤1ms)	
		EVR200	
Maximum Continuous Current		200A	
Maximum Cut Off	V	1000V DC	
	A	2000A 300VDC 1 Ops	
Min. Switching Capacity(Resistive Load)		1A 12VDC	
Short Term Current		300A 15min, 400A 240s, 800A 30s , 2000A 0.6s	
Contact Resistance		≤0.5mΩ (DC 200A)	
Contact Material		Alloy Cu	
Contact Arrangement		1 A (SPST-NO.)	

▶ PART NUMBERING RULE

Series	Rated Current	Auxiliary Contactor	Contactor type	Coil Voltage	Coil lead
EVR=Square type	200:200A	Null:NO auxiliary Contactor	1: 1a Normally Open	12: 12VDC 24:24VDC	D=direct wire without connection plug E=direct wire with connector plug

- Note: 1. specifications are obtained in the environment of 23 degrees C
2. maximum allowable contact temperature: 150 C; 175 degrees C 2Hmax; 200 degrees C 2minMax
3. the finished product withstand pressure / insulation is 50Mohm,
4.after the maximum limit cut-off, the auxiliary contacts can not meet the pressure insulation
5. coil resistance test error + 10%

DC HIGH VOLTAGE EV RELAY

EVR200



▶ INSULATION PERFORMANCE

Insulation Resistance		Min. 1000MΩ 1000V DC
Dielectric Strength	Between Open Contacts	2500V AC 60 Sec. 1 mA
	Between Contact And Coil	2500V AC 60 Sec. 1 mA
Operate Time(at 20 °C)		≤30ms
Release Time(at 20 °C)		≤10ms

▶ MECHANICAL PARAMETERS

Life	Mechanical Life		2x10 ⁵ Ops
	Electrical Life (Resistive Load) (L/R≤1ms)	450V DC 200A	6,000 Ops
750V DC 200A		1,000 Ops	
Shock Resistance	Functional		Min 196% {20G} 11ms ,(10μs)
	Destructive		Min 490% {50G} 6ms
Vibration Resistance	Functional		43% {5G} 10 to 200Hz,(10μs)
	Destructive		43% {5G} 10 to 200Hz 4h
Conditions For Operation, Transport And Storage	Ambient Temperature		-40°C to +85°C
	Humidity		5 to 95% R.H.
Weight			400g

▶ ENGINEERING DATA

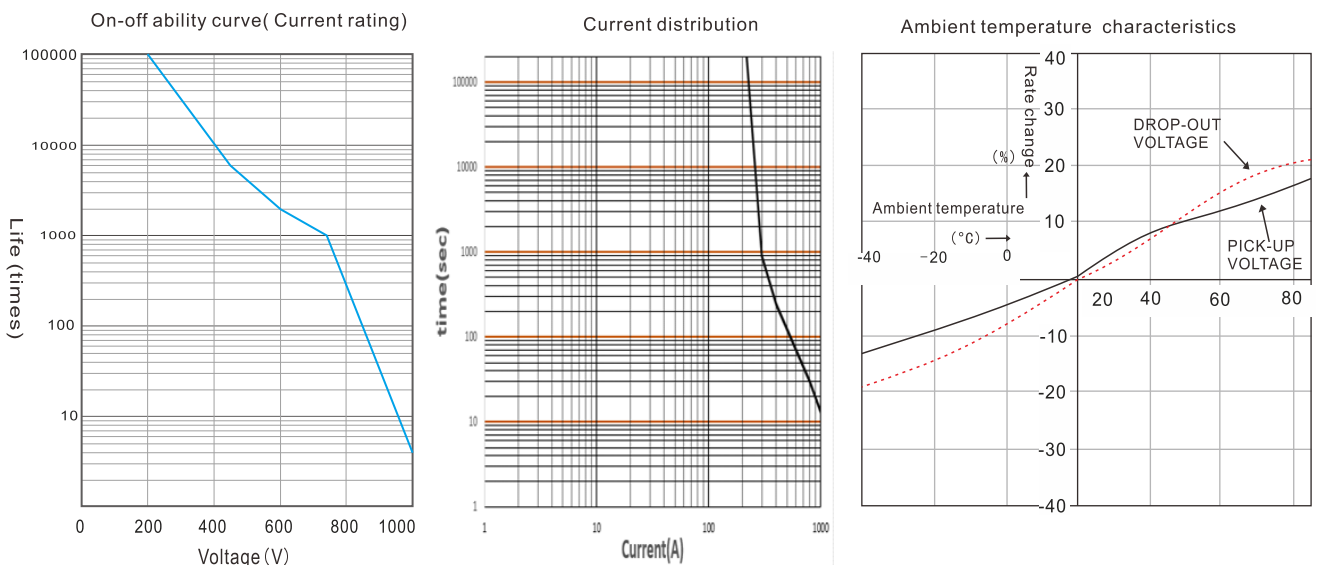

DC HIGH VOLTAGE EV RELAY

EVR200



▶ DIMENSIONAL DRAWING

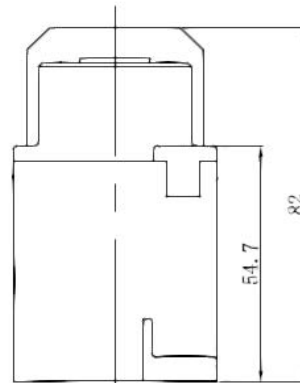
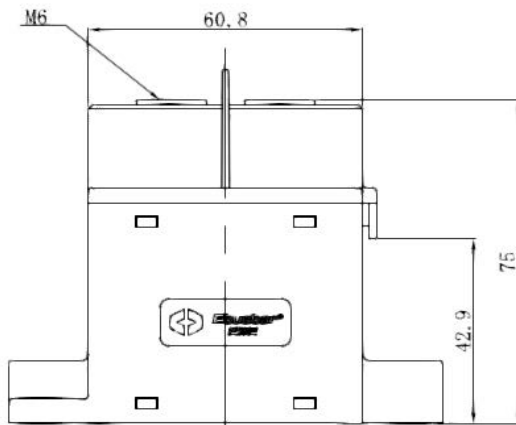
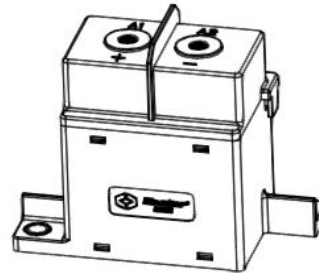
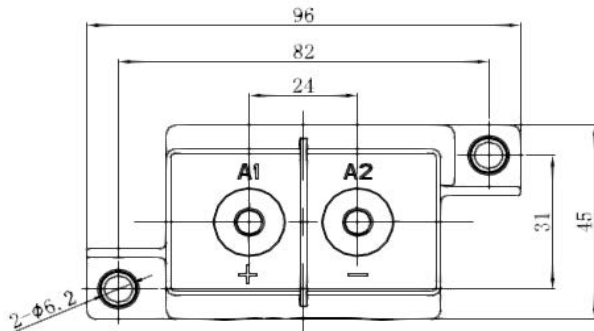

▶ SCHEMATIC

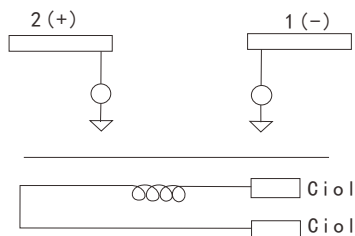

▶ MOUNTING DIMENSIONS

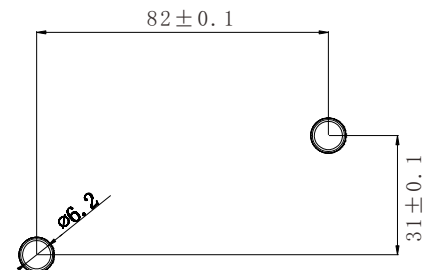

Tolerance:
dim < 10mm: ±0.3;
dim = 10~50mm: ±0.6;
dim > 50mm: ±1.0

EV RELAY APPLICATION PRECAUTIONS:

EV series high voltage DC relay with higher arc cooling capacity hydrogen medium, have the ability of DC high voltage cutting and adopt ceramic sealing explosion-proof structure. Contact part have waterproof, anti oxidation and other functions. It can be widely used in electric vehicles, hybrid vehicles, fuel cell vehicles, construction machinery, photovoltaic power generation, wind power generation, battery charging and discharging system, DC voltage power control and other DC high voltage fields.

Notes:

- 1.All types of relay terminals have polarity difference. Please use correctly according to the mark on each surface of the product. When the connection polarity is reversed, the electrical characteristics promised in the specification will not be guaranteed.
- 2.The rated value of contact parameters are the value of resistive load. Without measures, there may be a decline in electrical life and the occurrence of cut off. If using diodes, it may lead to a decline in cutting performance
- 3.During the action voltage test of double coil relay, voltage can not be risen slowly. Please drive the product coil through the fast rising (step type power supply mode) , otherwise the relay will not act.
- 4.Don't put the relay in the environment that over normal operating temperature (-40 degrees C to 85 C) for a long time.
- 5.Please avoid installing near in strong magnetic field (around transformer and magnet) and hot objects.
- 6.Make sure the main power line is closest to the relay leading-out terminal, then installed tightly according to the order of the flat washer, spring washer and nut. Incorrect connection order may cause serious overheating, and lead to the insulation layer melting of connecting cable .
- 7.Screw locking torque of every part should be accordant with following chart in case of breakage.

▶ Part I Leading-out terminal installation:

Nut	EVR20	EVR40	EVR100	EVR120	EVR150	EVR200	EVR250	EVR300	EVC50	EVC100	EVC135	EVC150	EVC 200 EVC250	EVC300 EVC350	EVC400 EVC500
M4		3N.m~4N.m							3N.m~4N.m	3N.m~4N.m	3N.m~4N.m				
M5			6N.m~8N.m	6N.m~8N.m	6N.m~8N.m										
M6						10N.m~12N.m	10N.m~12N.m	10N.m~12N.m				10N.m~12N.m	10N.m~12N.m	10N.m~12N.m	10N.m~12N.m
M8															

Remarks:EVC050,EVC100 Use screws;

▶ Part II Relay installation:

Screws	EVR20	EVR40	EVR100	EVR120	EVR150	EVR200	EVR250	EVR300	EVC50	EVC100	EVC135	EVC150	EVC200 EVC250	EVC300	EVC350	EVC400	EVC500
M4									2N.m~3N.m	2N.m~3N.m	2N.m~3N.m						
M5	3N.m~4N.m	3N.m~4N.m	3N.m~4N.m	3N.m~4N.m	3N.m~4N.m	3N.m~4N.m						3N.m~4N.m	3N.m~4N.m	3N.m~4N.m	3N.m~4N.m	3N.m~4N.m	3N.m~4N.m
M6	5N.m~6N.m	5N.m~6N.m	5N.m~6N.m	5N.m~6N.m	5N.m~6N.m	5N.m~6N.m	5N.m~6N.m	5N.m~6N.m				5N.m~6N.m	5N.m~6N.m	5N.m~6N.m	5N.m~6N.m	5N.m~6N.m	5N.m~6N.m
M8																	

Remarks: a. Screw strength must be in compliance with the requirements of grade 8.8 or above ; (GB/T70.1)
b. The effective locking thread length must be greater than 5mm;

8. Please avoid adhering grease and other foreign material on the leading-out terminal; Please use the following specifications of the connection wire, otherwise it may cause abnormal heat of the terminal part.

Product	EVT150	EVR20	EVR40	EVR100	EVR120	EVR150	EVR200 EVC 200	EVR250	EVR300	EVC50	EVC100	EVC135	EVC150	EVC250	EVC300	EVC350	EVC400	EVC500
Nominal sectional area (Min)	50mm ²	4mm ²	15mm ²	35mm ²	50mm ²	75mm ²	100mm ²	120mm ²	150mm ²	13mm ²	35mm ²	40mm ²	75mm ²	120mm ²	150mm ²	200mm ²	200mm ²	300mm ²

9.Packing specification

Each box	EVT150	EVR20	EVR40	EVR100	EVR120	EVR150	EVR200	EVR250	EVR300	EVC50	EVC100	EVC135	EVC150	EVC 200 EVC250	EVC300	EVC350	EVC400	EVC500
Specifications D*W*H	475*328 *113mm	362*357 *146mm	407*337 *131mm	482*457 *91mm	482*457 *91mm	532*432 *91mm	557*577 *96mm	557*577 *96mm	507*402 *119mm	412*407 *146mm	412*407 *146mm	412*407 *146mm	482*382 *106mm	482*382 *106mm	507*402 *119mm	507*402 *119mm	507*402 *119mm	507*402 *119mm
Number	40pcs	40pcs	40pcs	20pcs	20pcs	20pcs	20pcs	20pcs	15pcs	60pcs	60pcs	60pcs	20pcs	20pcs	20pcs	20pcs	20pcs	20pcs
Net weight	5.4kg	6.4kg	7.2kg	7kg	7kg	8kg	9.4kg	9.4kg	8kg	10.8kg	10.8kg	10.8kg	7.6kg	7.6kg	11kg	11kg	11kg	11kg
Monomer	0.13kg	0.16kg	0.18kg	0.35kg	0.35kg	0.4kg	0.47kg	0.47kg	0.53kg	0.18kg	0.18kg	0.18kg	0.38kg	0.38kg	0.55kg	0.55kg	0.55kg	0.55kg

Note: there is a shockproof bubble bag in the packing box, and there is shockproof foam inside the box;

- 10.In the case of accidental fall of the relay, see intended not to use.
- 11.Attentions and product technical data should be updated termly, and copyright by Ebusbar all.