

Metallized Polypropylene Film Capacitors (DC-link application)

PCPW 245

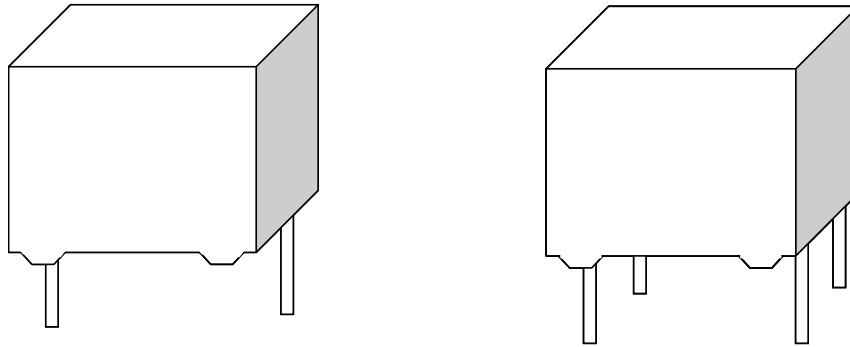

QUICK REFERENCE DATA

Capacitance range	1.5 μ F to 150 μ F
Capacitance tolerance	\pm 5%, \pm 10%
Rated voltage (V_{Rdc})	450, 700, 900, 1100Vdc
Non recurrent surge voltage (V_{pk})	563, 875, 1125, 1375Vdc
Max. repetitive peak voltage (V_{pkr})	1.15 x V_{Rdc} (max. 30min. within one day)
Max. non-repetitive peak current (I_{pkr})	1.5 x I_{pk}
Dissipation factor (DF)	0.0015 at 1KHz($C \leq 30\mu$ F), 0.0020 at 1KHz($C > 30\mu$ F)
Insulation resistance (IR)	3,000s after 1minute of electrification at 100(500)Vdc
Test voltage with terminals (V_{tt})	1.5 x V_{Rdc} applied for 10s
Test voltage with terminals (V_{tc})	3KV 50-60Hz applied for 60s
IEC Climatic category	40/ 105 / 56
Temperature range	-40 $^{\circ}$ C ~ +105 $^{\circ}$ C
Life time expectancy	100,000 hours at V_R , 70 $^{\circ}$ C 40,000 hours at V_R , 85 $^{\circ}$ C
Reference	IEC 60384-16 / IEC61071
Potting & Encapsulation material	Qualified in accordance with UL94V-0

FEATURES	APPLICATIONS
<ul style="list-style-type: none"> . Self-Healing . High capacitance density . High ripple current . Low contact resistance . Low loss dielectric 	<ul style="list-style-type: none"> . dc-link applications. . High frequency, high current applications . Industrial and motor speed control . Welding equipment

- Please refer to caution and warning at <http://www.pilkor.co.kr/download/Introductions.pdf> before using these products.

Ordering Information

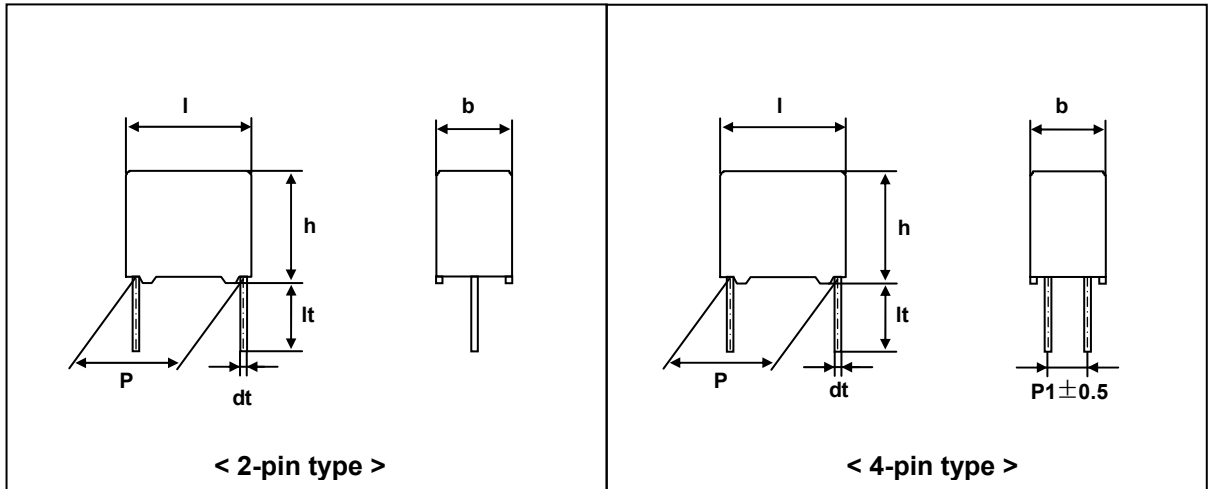

PCPW 245 X X X X X

Type series

Capacitance

Code	Voltage
L	450V
R	700V
S	900V
T	1100V

Code	Original pitch
L	27.5mm
Q	37.5mm
T	52.5mm

Available versions					Product (I _{max})		
Code	Packing method	C-tol.	Lead length & Height	Lead Type	31.0	42.0	57.0
					Pitch (P)		
6	Loose in box	±10%	lt = 5.0±1.0mm	2-pin	27.5	-	-
7	Loose in box	±5%	lt = 5.0±1.0mm	2-pin	27.5	-	-
3	Loose in box	±10%	lt = 25.0±2.0mm	2-pin	27.5	-	-
5	Loose in box	±5%	lt = 25.0±2.0mm	2-pin	27.5	-	-
2	Arrange Pack.	±10%	lt = 5.0±1.0mm	2-pin	27.5	37.5	-
4	Arrange Pack.	±5%	lt = 5.0±1.0mm	2-pin	27.5	37.5	-
A	Arrange Pack.	±10%	lt = 5.0±1.0mm	4-pin	-	37.5	52.5
D	Arrange Pack.	±5%	lt = 5.0±1.0mm	4-pin	-	37.5	52.5

Packing Information

SMALLEST PACKING QUANTITIES (SPQ)	Loose in box		Arrange Pack.
	It = 5.0 ± 1.0mm	It = 25.0 ± 2.0mm	It = 5.0 ± 1.0mm
13.0 x 23.0 x 31.0	250	250	100
15.0 x 25.0 x 31.0	250	250	120
18.0 x 28.0 x 31.0	200	200	100
21.0 x 31.0 x 31.0	150	150	60
18.0 x 33.0 x 42.0	-	-	100
20.0 x 35.0 x 42.0	-	-	90
24.0 x 39.0 x 42.0	-	-	75
28.0 x 43.0 x 42.0	-	-	65
30.0 x 45.0 x 42.0	-	-	60
30.0 x 45.0 x 57.0	-	-	40
35.0 x 50.0 x 57.0	-	-	40
45.0 x 55.0 x 57.0	-	-	30
45.0 x 65.0 x 57.0	-	-	30

Metallized Polypropylene Film Capacitors (DC-link application)

 $V_{Rdc} = 450Vdc$ $V_{pk} = 563 Vdc$

Cap (μF)	b x h x l (mm)	P1 \pm 0.5 (mm)	dv/dt (V/us)	l _{pk} (A)	I _{rms} ⁽¹⁾ (A)		ESR ⁽²⁾ (m Ω)		Code				
									PCPW 245.....				
		4-pin			2-pin		4-pin		Arrange Pack.		Tol. \pm 5% / lt = 5 \pm 1 mm		
											2-pin	4-pin	
Pitch = 27.5 \pm 0.4 mm									dt = 0.8	dt = 1.2			
5	18.0 x 28.0 x 31.0	-	30	150	5.0	-	8.5	-	LL4505	-			
10	18.0 x 28.0 x 31.0	-	30	300	9.0	-	8.0	-	LL4106	-			
15	21.0 x 31.0 x 31.0	-	30	450	11.0	-	6.5	-	LL4156	-			
Pitch = 37.5 \pm 0.7 mm									dt = 1.0	dt = 1.2			
15	18.0 X 33.0 X 42.0	10.2	21	315	6.8	7.8	6.7	6.2	QL4156	QLD156			
20	18.0 X 33.0 X 42.0	10.2	21	420	6.8	7.8	6.7	6.2	QL4206	QLD206			
22	20.0 X 35.0 X 42.0	10.2	21	462	8.2	9.2	6.0	5.5	QL4226	QLD226			
25	20.0 X 35.0 X 42.0	10.2	21	525	10.0	11.0	5.2	4.8	QL4256	QLD256			
30	24.0 X 39.0 X 42.0	10.2	21	630	12.2	13.2	3.8	3.5	QL4306	QLD306			
35	24.0 X 39.0 X 42.0	10.2	21	735	13.5	14.5	3.2	2.5	QL4356	QLD356			
40	28.0 X 43.0 X 42.0	10.2	21	840	14.1	15.1	2.9	2.4	QL4406	QLD406			
45	28.0 X 43.0 X 42.0	10.2	21	945	14.4	15.4	2.7	2.2	QL4456	QLD456			
50	30.0 X 45.0 X 42.0	20.3	21	1050	14.7	15.7	2.7	2.2	QL4506	QLD506			
Pitch = 52.5 \pm 0.7 mm									dt = 1.2	dt = 1.2			
55	30.0 X 45.0 X 57.0	20.3	14	770	-	15.0	-	5.0	-	TLD556			
60	30.0 X 45.0 X 57.0	20.3	14	840	-	15.5	-	4.5	-	TLD606			
75	30.0 X 45.0 X 57.0	20.3	14	1050	-	16.0	-	4.0	-	TLD756			
100	35.0 X 50.0 X 57.0	20.3	14	1400	-	18.0	-	3.5	-	TLD107			
110	35.0 X 50.0 X 57.0	20.3	14	1540	-	19.0	-	3.1	-	TLD117			
120	45.0 X 55.0 X 57.0	20.3	14	1680	-	21.5	-	2.8	-	TLD127			
130	45.0 X 55.0 X 57.0	20.3	14	1820	-	23.5	-	2.8	-	TLD137			
140	45.0 X 55.0 X 57.0	20.3	14	1960	-	25.2	-	2.5	-	TLD147			
150	45.0 X 55.0 X 57.0	20.3	14	2100	-	27.0	-	2.5	-	TLD157			

⁽¹⁾ Max. at 10KHz, +70°C⁽²⁾ Typical values at 10KHz

Metallized Polypropylene Film Capacitors (DC-link application)

PCPW 245

 $V_{Rdc} = 700Vdc$ $V_{pk} = 875 Vdc$

Cap (μF)	b x h x l (mm)	P1 \pm 0.5 (mm)	dv/dt (V/us)	Ipk (A)	I _{rms} ⁽¹⁾ (A)		ESR ⁽²⁾ (m Ω)		Code	
									PCPW 245	
									Arrange Pack.	
									Tol. \pm 5% / lt = 5 \pm 1 mm	
		4-pin			2-pin	4-pin	2-pin	4-pin	2-pin	4-pin
Pitch = 27.5 \pm 0.4 mm										
									dt = 0.8	dt = 1.2
3	15.0 x 25.0 x 31.0	-	40	120	4.2	-	9.0	-	LR4305	-
5	18.0 x 28.0 x 31.0	-	40	300	5.0	-	8.5	-	LR4505	-
8	21.0 x 31.0 x 31.0	-	40	320	6.0	-	8.0	-	LR4805	-
Pitch = 37.5 \pm 0.7 mm										
									dt = 1.0	dt = 1.2
10	18.0 X 33.0 X 42.0	10.2	22	220	6.6	7.1	9.2	8.7	QR4106	QRD106
12	20.0 X 35.0 X 42.0	10.2	22	264	8.2	8.6	7.8	7.3	QR4126	QRD126
15	24.0 X 39.0 X 42.0	10.2	22	330	9.8	10.3	6.0	5.5	QR4156	QRD156
20	24.0 X 39.0 X 42.0	10.2	22	440	11.8	12.3	4.1	3.6	QR4206	QRD206
22	28.0 X 43.0 X 42.0	10.2	22	484	12.3	12.8	3.7	3.1	QR4226	QRD226
25	28.0 X 43.0 X 42.0	10.2	22	550	12.9	13.4	3.4	2.9	QR4256	QRD256
30	30.0 X 45.0 X 42.0	20.3	22	660	13.5	14.0	3.1	2.6	QR4306	QRD306
Pitch = 52.5 \pm 0.7 mm										
									dt = 1.2	dt = 1.2
45	30.0 X 45.0 X 57.0	20.3	15	675	-	16.0	-	3.0	-	TRD456
55	35.0 X 50.0 X 57.0	20.3	15	825	-	17.0	-	3.5	-	TRD556
60	35.0 X 50.0 X 57.0	20.3	15	900	-	19.0	-	3.0	-	TRD606
70	45.0 X 55.0 X 57.0	20.3	15	1050	-	21.0	-	2.7	-	TRD706
80	45.0 X 55.0 X 57.0	20.3	15	1200	-	24.0	-	2.5	-	TRD806
90	45.0 X 65.0 X 57.0	20.3	15	1350	-	27.0	-	2.3	-	TRD906
100	45.0 X 65.0 X 57.0	20.3	15	1500	-	30.0	-	2.0	-	TRD107

⁽¹⁾ Max. at 10KHz, +70 $^{\circ}$ C⁽²⁾ Typical values at 10KHz

Metallized Polypropylene Film Capacitors (DC-link application)

PCPW 245

 $V_{Rdc} = 900Vdc$ $V_{pk} = 1125 Vdc$

Cap (μF)	b x h x l (mm)	P1 \pm 0.5 (mm)	dv/dt (V/us)	Ipk (A)	I _{rms} ⁽¹⁾ (A)		ESR ⁽²⁾ (m Ω)		Code	
									PCPW 245	
		4-pin			Arrange Pack.		Tol. \pm 5% / lt = 5 \pm 1 mm			
					2-pin	4-pin	2-pin	4-pin	2-pin	4-pin
Pitch = 27.5 \pm 0.4 mm									dt = 0.8	dt = 1.2
2	15.0 x 25.0 x 31.0	-	75	150	4.0	-	7.0	-	LS4205	-
5	21.0 x 31.0 x 31.0	-	75	375	6.5	-	6.0	-	LS4505	-
Pitch = 37.5 \pm 0.7 mm									dt = 1.0	dt = 1.2
8	20.0 X 35.0 X 42.0	10.2	54	432	6.6	8.0	9.2	8.7	QS4805	QSD805
10	24.0 X 39.0 X 42.0	10.2	54	540	8.2	9.4	7.8	7.3	QS4106	QSD106
12	24.0 X 39.0 X 42.0	10.2	54	648	9.8	11.0	6.0	5.5	QS4126	QSD126
15	28.0 X 43.0 X 42.0	10.2	54	810	11.8	12.8	4.1	3.6	QS4156	QSD156
18	30.0 X 45.0 X 42.0	20.3	54	972	12.3	13.3	3.7	3.2	QS4186	QSD186
Pitch = 52.5 \pm 0.7 mm									dt = 1.2	dt = 1.2
20	30.0 X 45.0 X 57.0	20.3	35	700	-	10.0	-	11.0	-	TSD206
25	30.0 X 45.0 X 57.0	20.3	35	875	-	11.5	-	9.0	-	TSD256
30	35.0 X 50.0 X 57.0	20.3	35	1050	-	13.0	-	7.0	-	TSD306
35	35.0 X 50.0 X 57.0	20.3	35	1225	-	15.5	-	6.0	-	TSD356
40	45.0 X 55.0 X 57.0	20.3	35	1400	-	16.0	-	5.7	-	TSD406
45	45.0 X 55.0 X 57.0	20.3	35	1575	-	18.0	-	5.5	-	TSD456
50	45.0 X 55.0 X 57.0	20.3	35	1750	-	20.0	-	5.3	-	TSD506
55	45.0 X 65.0 X 57.0	20.3	35	1925	-	22.0	-	5.1	-	TSD556
60	45.0 X 65.0 X 57.0	20.3	35	2100	-	25.0	-	4.9	-	TSD606

⁽¹⁾ Max. at 10KHz, +70°C⁽²⁾ Typical values at 10KHz

Metallized Polypropylene Film Capacitors (DC-link application)

PCPW 245

 $V_{Rdc} = 1100Vdc$ $V_{pk} = 1375 Vdc$

Cap (μF)	b x h x l (mm)	P1 \pm 0.5 (mm)	dv/dt (V/us)	l _{pk} (A)	I _{rms} ⁽¹⁾ (A)		ESR ⁽²⁾ (m Ω)		Code	
									PCPW 245	
									Arrange Pack.	
									Tol. \pm 5% / lt = 5 \pm 1 mm	
		4-pin			2-pin	4-pin	2-pin	4-pin	2-pin	4-pin
Pitch = 27.5 \pm 0.4 mm										
									dt = 0.8	dt = 1.2
1.5	15.0 x 25.0 x 31.0	-	100	150	4.5	-	7.5	-	LT4155	-
3	21.0 x 31.0 x 31.0	-	100	300	6.0	-	6.5	-	LT4305	-
Pitch = 37.5 \pm 0.7 mm										
									dt = 1.0	dt = 1.2
5	18.0 X 33.0 X 42.0	10.2	73	365	7.1	7.6	9.3	8.3	QT4505	QTD505
6	20.0 X 35.0 X 42.0	10.2	73	438	7.7	8.2	8.5	7.5	QT4605	QTD605
8	24.0 X 39.0 X 42.0	10.2	73	584	9.1	9.6	6.9	6.4	QT4805	QTD805
10	28.0 X 43.0 X 42.0	10.2	73	730	10.3	10.8	5.4	4.9	QT4106	QTD106
12	28.0 X 43.0 X 42.0	10.2	73	876	11.6	12.1	4.3	3.7	QT4126	QTD126
Pitch = 52.5 \pm 0.7 mm										
									dt = 1.2	dt = 1.2
15	30.0 X 45.0 X 57.0	20.3	50	750	-	10.5	-	10.5	-	TTD156
20	35.0 X 50.0 X 57.0	20.3	50	1000	-	12.5	-	8.0	-	TTD206
25	35.0 X 50.0 X 57.0	20.3	50	1250	-	15.0	-	6.5	-	TTD256
30	45.0 X 55.0 X 57.0	20.3	50	1500	-	17.5	-	6.0	-	TTD306
35	45.0 X 55.0 X 57.0	20.3	50	1750	-	20.5	-	5.5	-	TTD356
40	45.0 X 65.0 X 57.0	20.3	50	2000	-	22.5	-	5.2	-	TTD406
45	45.0 X 65.0 X 57.0	20.3	50	2250	-	24.5	-	4.9	-	TTD456

⁽¹⁾ Max. at 10KHz, +70°C⁽²⁾ Typical values at 10KHz

CHARACTERISTICS

● Test Voltage

- . Test Voltage (between terminations) : $1.5 \times V_R$ applied for 10s
- . Test Voltage (between leads and case) : 3KV 50-60Hz applied for 60s

● Dissipation Factor

Rated voltage	Capacitance	Dissipation factor ($\times 10^{-4}$)	
		1 kHz	10 kHz
450Vdc / 700Vdc	$C \leq 30\mu\text{F}$	≤ 15	
900Vdc / 1100Vdc	$C > 30\mu\text{F}$	≤ 20	

● Insulation Resistance

The insulation resistance is measured after a voltage has been applied for 1minute ± 5 second.

The voltage being $100 \pm 15\text{V}$ for the 450V versions and $500\text{V} \pm 50\text{V}$ for the 700V / 900V / 1100V versions

Pitch : 27.5mm ; RC ($\Omega \cdot \text{F}$) $> 30,000 \text{ s}$

Pitch : 37.5mm & 52.5mm ; RC ($\Omega \cdot \text{F}$) $> 10,000 \text{ s}$

THE GRAPHS OF CHARACTERISTICS

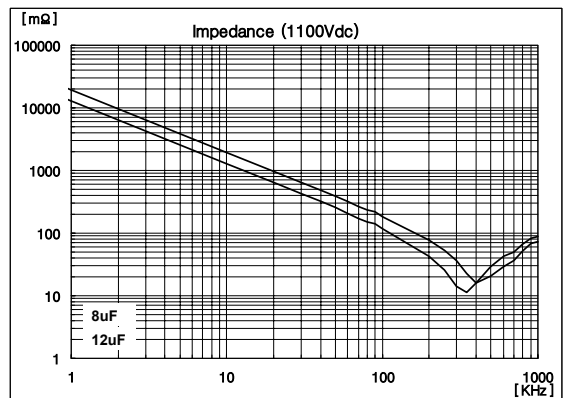
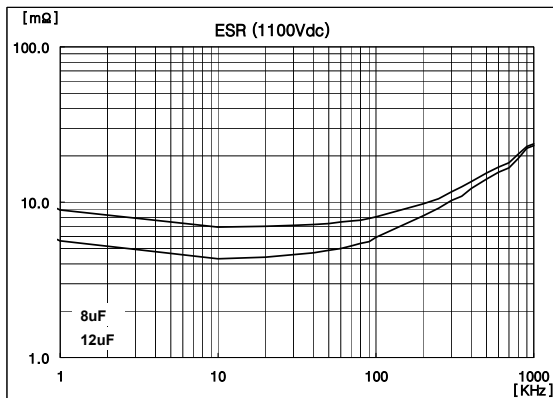
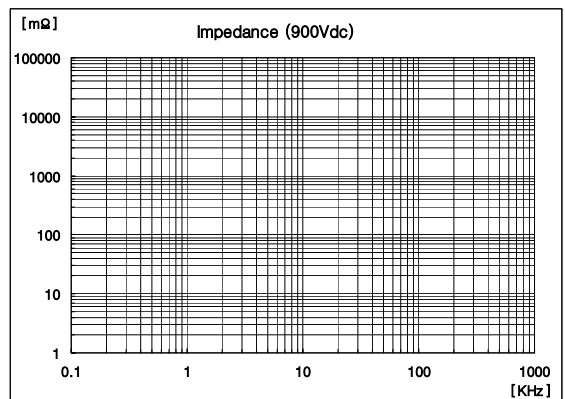
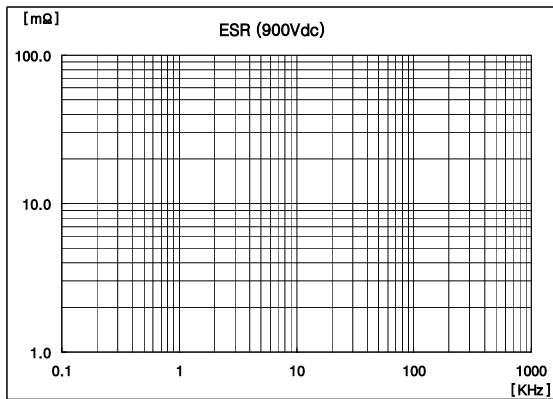
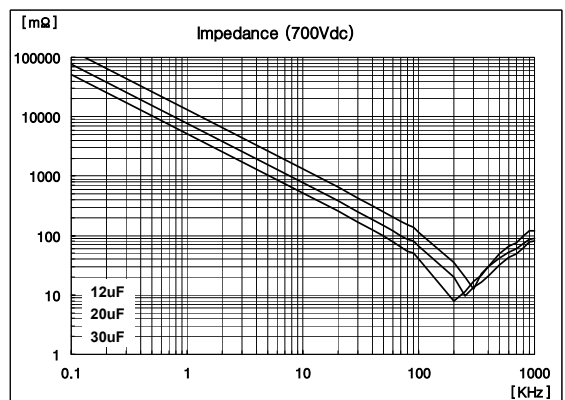
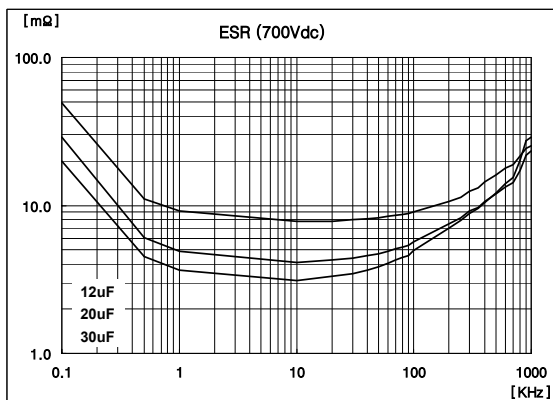
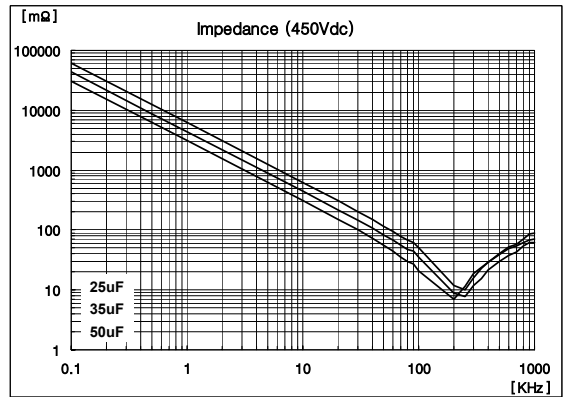
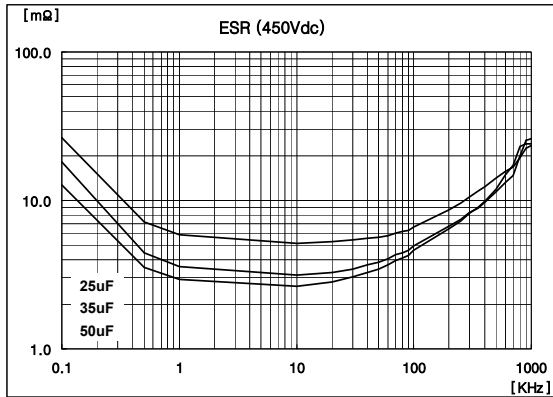

PERMISSIBLE VOLTAGE AND CURRENT AS A FUNCTION OF FREQUENCY

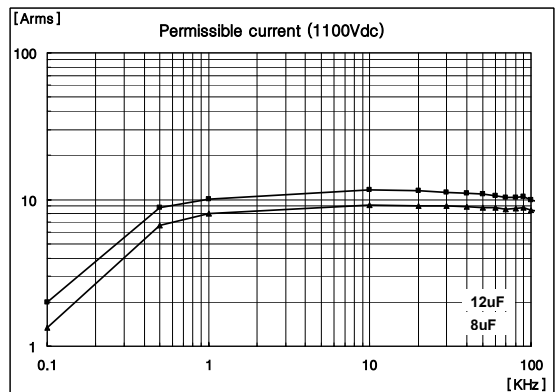
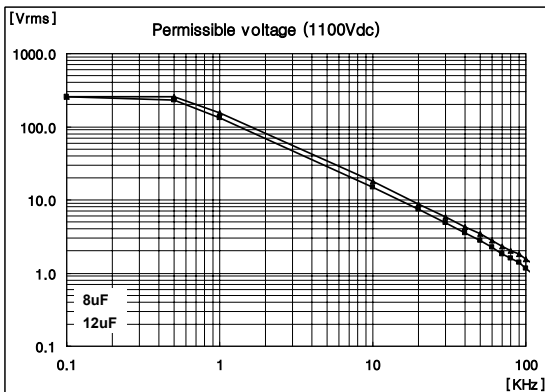
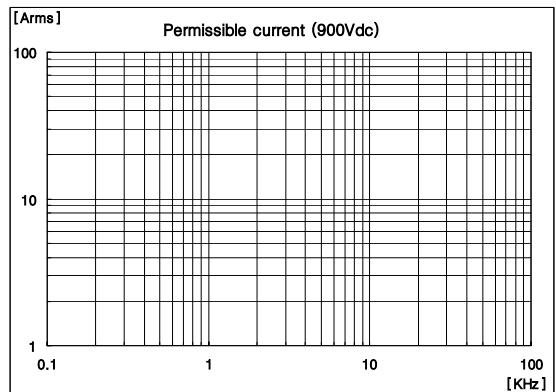
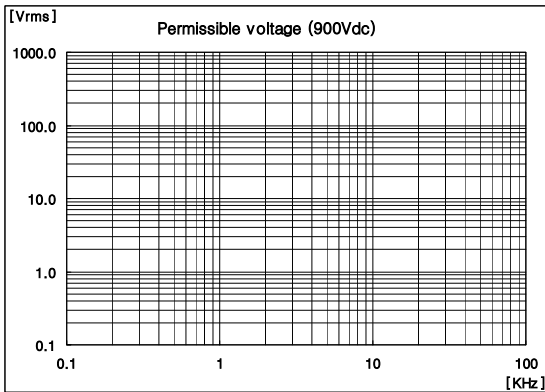
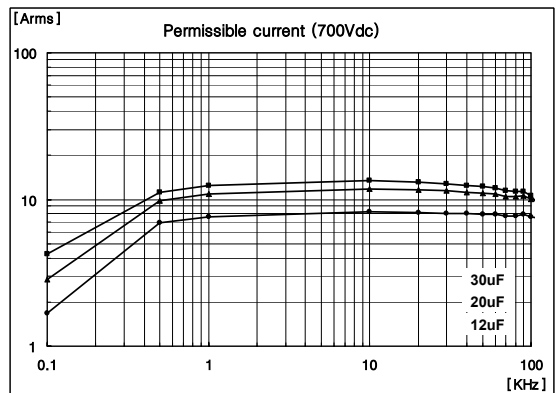
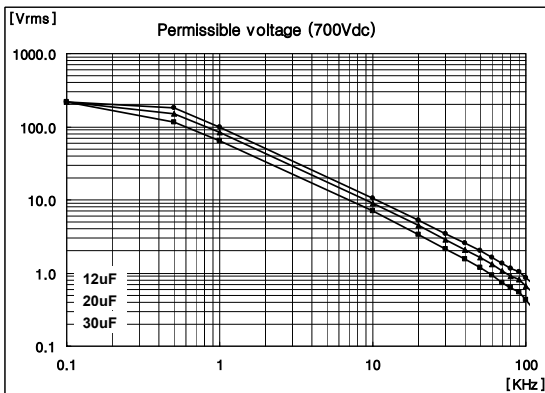
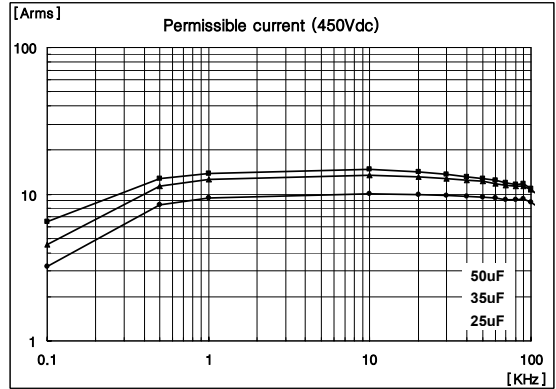
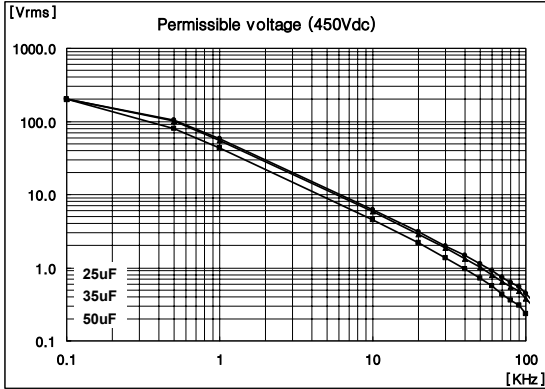

PRODUCT MARKING

Capacitors are marked on the top or on the top and one side with the following information :

- . Rated capacitance code in accordance with IEC 60062
- . Tolerance on rated capacitance : J : $\pm 5\%$ K : $\pm 10\%$
- . Rated (DC) Voltage (e.g. 450 V)
- . Code for dielectric material (MKP)
- . Manufacturer's type designation (PCPW 245)
- . Manufacturer's name (PILKOR)

Example of marking

20u	K	450V	PILKOR
PCPW 245	MKP	WK...	

Marking on the top or side