





Product Approval Sheet

Customer : WPI

Issued no : 2014. 09. 22.

Revision no :

- **Product description :** Metallized Polyester film capacitors
- **Product code :** PCMT 468 S0122 ~ PCMT 468 S0129
- **Application :**

CUSTOMER			
PILKOR	Checked	Confirmed	Approved
			

Headquarters : 381, Woncheon-dong, Yeong tong-gu, Suwon-si, Gyeonggi-do, Korea

PILKOR Electronics Co., Ltd.

TEL. +82-31-217-2500

FAX. +82-31-217-7465

China factory : No 25 Zoutai South Road Rongcheng City, Shandong Province China

Rongcheng PILKOR Electronics Co., Ltd.

TEL. +86-631-755-6001~3

FAX. +86-631-755-6004

*** Please send it back to us before placing order.**

(Contents)

1.		Page 1
	(General)	
2.		Page 10
	(Characteristics)	
3.		Page 13
	(Mark & Packing)	
4.		Page 17
	(Test Requirements)	

* Construction

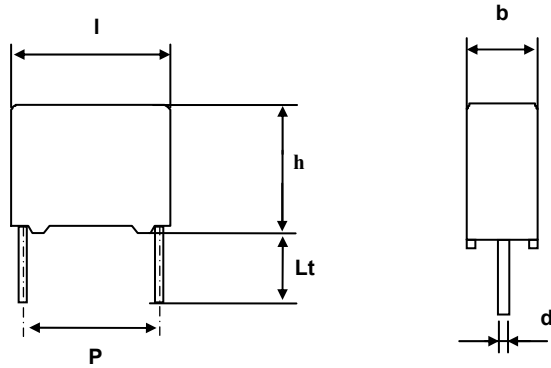

Voltage V [⚡]	Cap. μF	Code		Dimensions			P mm	Lt mm	dt mm
		PCMT 468	C-tol.	$b \times h \times l$ mm					
250V	0.47	S0122	$\pm 10 \%$	6.0 x 12.0 x 12.5			10.0 \pm 0.4	5.0 \pm 1.0	0.6+0.08/-0.05
250V	0.68	S0123	$\pm 10 \%$	7.0 x 13.5 x 18.0			15.0 \pm 0.4	5.0 \pm 1.0	0.8+0.08/-0.05
250V	1.5	S0124	$\pm 10 \%$	8.5 x 15.0 x 18.0			15.0 \pm 0.4	5.0 \pm 1.0	0.8+0.08/-0.05
250V	2.2	S0125	$\pm 10 \%$	11.0 x 18.5 x 18.0			15.0 \pm 0.4	5.0 \pm 1.0	0.8+0.08/-0.05
400V	0.1	S0126	$\pm 10 \%$	6.0 x 12.0 x 12.5			10.0 \pm 0.4	5.0 \pm 1.0	0.6+0.08/-0.05
400V	0.47	S0127	$\pm 10 \%$	8.5 x 15.0 x 18.0			15.0 \pm 0.4	5.0 \pm 1.0	0.8+0.08/-0.05
630V	0.1	S0128	$\pm 10 \%$	7.0 x 13.5 x 18.0			15.0 \pm 0.4	5.0 \pm 1.0	0.8+0.08/-0.05

Same as PCMT 468D43474/ 43684/F43155/FA3225/ 83104/ 83474/ 63104

DRAFT

<BUT>

- Temperature range : $-55^{\circ}C \sim +125^{\circ}C$
- Climatic category : 55/125/56

- Rated Voltage Pulse Load Slope $(dV/dt)_R$

12 NC	$dV/dt (V/\mu s)$
PCMT 468 S0122	150
PCMT 468 S0123	100
PCMT 468 S0124	100
PCMT 468 S0125	100
PCMT 468 S0126	175
PCMT 468 S0127	125
PCMT 468 S0128	150

박주영		MKT RADIAL POTTED CAPACITORS (WPI)			PCMT 468 S0122 ~ S0128		14-08-23	
김희철							14-09-22	
			14-08-23	1	190-1	010	QS	A4
QS	박범학	(C) PILKOR ELECTRONICS CO., LTD. 2014						

DRAFT

- Packing Method (Loose in box)

12 NC	Packing method	SPQ (Inner box)	PQ (Outer box)
PCMT 468 S0122	8242 450 40022	1000 (8242 451 30171)	4000 (8242 451 30261)
PCMT 468 S0123	8242 450 40024	1000 (8242 451 30191)	4000 (8242 451 30281)
PCMT 468 S0124	8242 450 40025	1000 (8242 451 30201)	4000 (8242 451 30291)
PCMT 468 S0125	8242 450 40027	1000 (8242 451 30221)	4000 (8242 451 30311)
PCMT 468 S0126	8242 450 40022	1000 (8242 451 30171)	4000 (8242 451 30261)
PCMT 468 S0127	8242 450 40025	1000 (8242 451 30201)	4000 (8242 451 30291)
PCMT 468 S0128	8242 450 40024	1000 (8242 451 30191)	4000 (8242 451 30281)

- Endurance (DC)

Test	Conditions	Requirements
4.12 Endurance (DC)	1000hours - 85°C ; Vdc x 1.25 - 105°C ; Vdc x 1.25 x 0.75 - 125°C ; Vdc x 1.25 x 0.5	No visible damage, Legible marking $\Delta C/C \leq 8\%$, $\Delta \tan \delta < 0.0050$ $R_{ins} \geq 50\%$ specified value

박 주 영		MKT			PCMT 468 S0122		14-09-22	
김 희 철		RADIAL POTTED CAPACITORS			~ S0128			
		(WPI)						
			14-09-22	1	190-2	010	QS	A4
QS	박범학	(C) PILKOR ELECTRONICS CO., LTD. 2014						

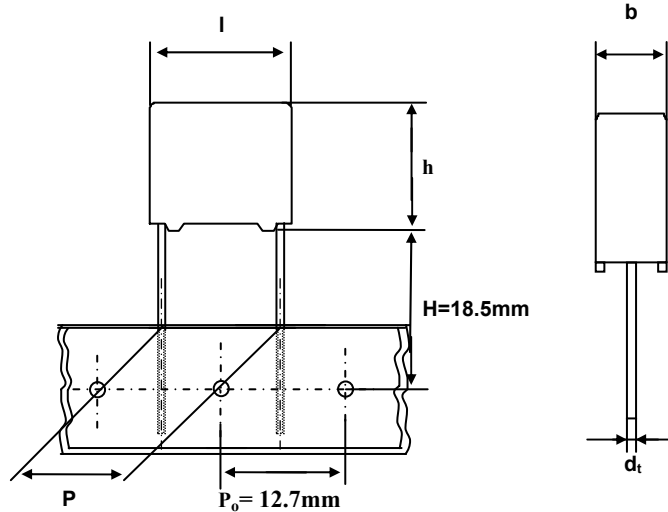

Voltage V ^r	Cap. μF	Code PCMT 468	C-tol.	Dimensions b × h × l mm	P mm	dt mm
400V	0.15	S0129	± 10 %	6.0 x 12.0 x 12.5	10.0±0.4	0.6+0.06/-0.05

Same as PCMT 468 89104

DRAFT

<BUT>

- Value Extension : Capacitance = 0.15uF
- Temperature range : -55°C ~ +125°C
- Climatic category : 55/125/56

- Rated Voltage Pulse Load Slope (dV/dt)_R

12 NC	dV/dt (V/μs)
PCMT 468 S0129	175

- Packing Method : Ammo packing

Code	Packing method	SPQ (Inner box)	PQ (Outer box)
PCMT 468 S0129	8242 450 40051	600 (8242 451 10111)	3000 (8242 451 30521)

- Endurance (DC)

Test	Conditions	Requirements
4.12 Endurance (DC)	1000hours - 85°C ; Vdc x 1.25 - 105°C ; Vdc x 1.25 x 0.75 - 125°C ; Vdc x 1.25 x 0.5	No visible damage, Legible marking ΔC/C≤8%, Δtanδ<0.0050 R _{ins} ≥50% specified value

박 주 영		MKT				14-08-23
김 희 철		RADIAL POTTED CAPACITORS (WPI)		PCMT 468 S0129		
			14-08-23	1	190-1	010
QS	박범학					QS A4
(C) PILKOR ELECTRONICS CO., LTD. 2014						

MKT RADIAL POTTED CAPACITORS

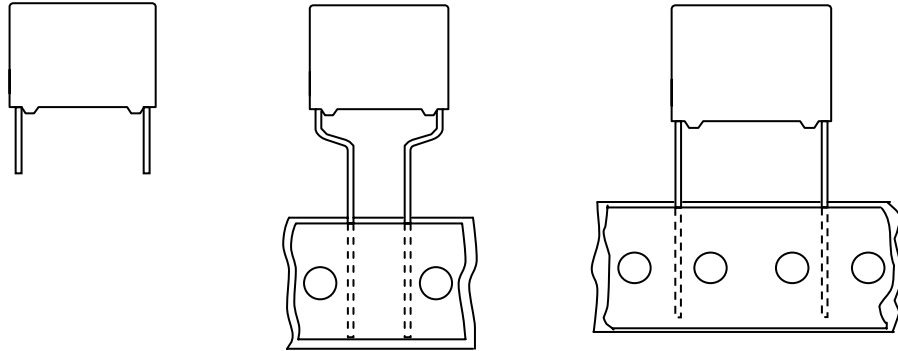
 Pitch 10.0/15.0/22.5/27.5mm
(reduced pitch ; 7.5mm)

QUICK REFERENCE DATA

Capacitance range (E24 series)	0.01 to 12 μ F
Capacitance tolerance	$\pm 5\%$, $\pm 10\%$,
Rated voltage (DC)	100V, 250V, 400V, 630V
Climatic category	55/105/56
Temperature range	-55 $^{\circ}$ C ~ +105 $^{\circ}$ C
Reference specification	IEC 60384-2
Potting & Encapsulation material	Qualified in accordance with UL94V-0

FEATURES	APPLICATIONS
<ul style="list-style-type: none"> . Low inductive wound cell of metallized (PETP) film . Supplied loose in box and ammpack 	<ul style="list-style-type: none"> . General purpose . Blocking and coupling . Bypass and energy reservoir application

- Please refer to caution and warning at <http://www.pilkor.co.kr/download/Introductions.pdf> before using these products.

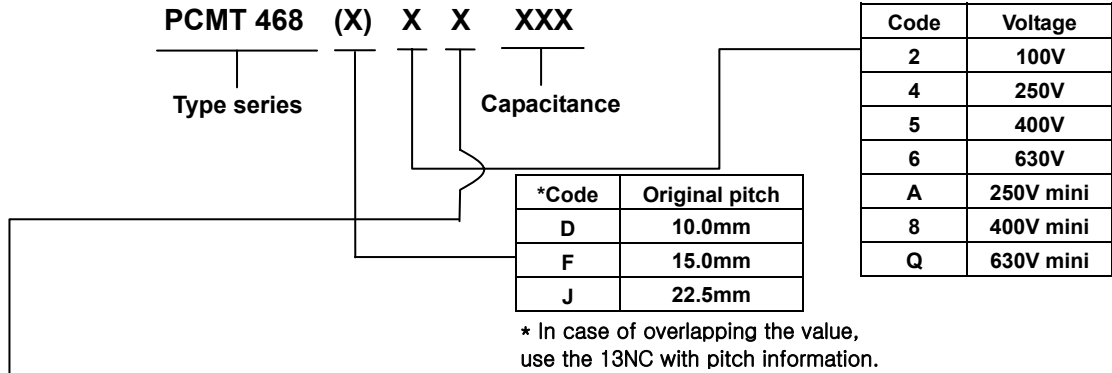
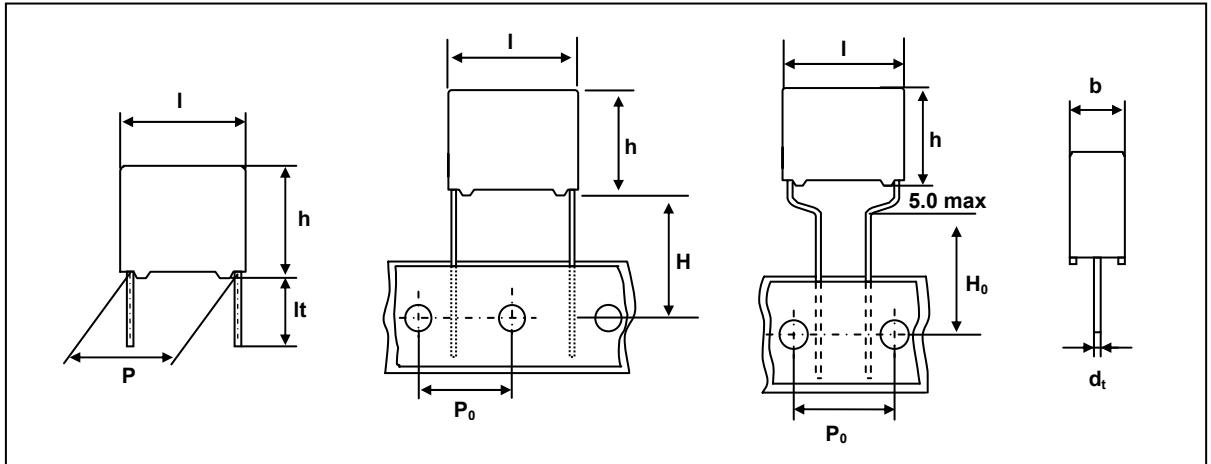
Ordering Information



Available versions					Product (l _{max})			
Code	Packing method	C-tol.	Lead length & Height	Hole to hole (P ₀)	12.5	18.0	26.0	31.0
					Pitch (P)			
2	Loose in box	± 5%	lt = 5.0±1.0mm	-	10.0	15.0	22.5	27.5
3	Loose in box	±10%	lt = 5.0±1.0mm	-	10.0	15.0	22.5	27.5
4	Loose in box	± 5%	lt = 25.0±2.0mm	-	10.0	15.0	22.5	27.5
5	Loose in box	±10%	lt = 25.0±2.0mm	-	10.0	15.0	22.5	27.5
8	Ammo packing	± 5%	H = 18.5mm	12.7mm	10.0	15.0	22.5	27.5
9	Ammo packing	±10%	H = 18.5mm	12.7mm	10.0	15.0	22.5	27.5
A	Ammo packing	± 5%	H ₀ = 16.0mm	15.0mm	7.5(*)	7.5(*)	-	-
B	Ammo packing	±10%	H ₀ = 16.0mm	15.0mm	7.5(*)	7.5(*)	-	-

* Reduced pitch (reduced lead spacings)

Packaging Information

SMALLEST PACKING QUANTITIES (SPQ)	Loose in box	
	lt = 5.0 ± 1.0 mm	lt = 25.0 ± 2.0 mm
DIMENSIONS	SPQ	SPQ
4.0 x 10.0 x 12.5	2000	1200
5.0 x 11.0 x 12.5	1500	1000
6.0 x 12.0 x 12.5	1000	1000
5.0 x 11.0 x 18.0	1000	1000
6.0 x 12.0 x 18.0	1000	1000
7.0 x 13.5 x 18.0	1000	1000
8.5 x 15.0 x 18.0	1000	1000
10.0 x 16.5 x 18.0	1000	1000
11.0 x 18.5 x 18.0	1000	1000
7.0 x 16.5 x 26.0	1000	1000
8.5 x 18.0 x 26.0	500	500
10.0 x 19.5 x 26.0	500	500
13.0 x 23.0 x 26.0	500	500
11.0 x 21.0 x 31.0	500	250
13.0 x 23.0 x 31.0	250	250
15.0 x 25.0 x 31.0	250	250
18.0 x 28.0 x 31.0	200	200

**Metallized Polyester
film capacitors**
PCMT 468
 $V_{Rdc} = 100V$
 $V_{Rac} = 63V\sim$

Cap. (μF)	b x h x l (mm)	Mass (g)	CATALOGUE NUMBER	
			PCMT 468	
			loose in box	
			It = 5 \pm 1 mm	
			C-tol. \pm 5 %	C-tol. \pm 10 %
Pitch = 10.0 \pm 0.4 mm			dt = 0.6 +0.06/-0.05 mm	
0.22 0.27 0.33	4.0 x 10.0 x 12.5	0.8	PCMT 468 22224 PCMT 468 22274 PCMT 468 22334	PCMT 468 23224 PCMT 468 23274 PCMT 468 23334
0.39 0.47	5.0 x 11.0 x 12.5	0.9	PCMT 468 22394 PCMT 468 22474	PCMT 468 23394 PCMT 468 23474
0.56 0.68 0.82 1.0	6.0 x 12.0 x 12.5	1.0	PCMT 468 22564 PCMT 468 22684 PCMT 468D22824 PCMT 468D22105	PCMT 468 23564 PCMT 468 23684 PCMT 468D23824 PCMT 468D23105
1.2 1.5	5.0 x 11.0 x 12.5	0.9	PCMT 468D22125 PCMT 468D22155	PCMT 468D23125 PCMT 468D23155
1.8 2.2	6.0 x 12.0 x 12.5	1.0	PCMT 468D22185 PCMT 468D22225	PCMT 468D23185 PCMT 468D23225
Pitch = 15.0 \pm 0.4 mm			dt = 0.8 +0.08/-0.05 mm	
0.82	5.0 x 11.0 x 18.0	1.2	PCMT 468 22824	PCMT 468 23824
1.0 1.2	6.0 x 12.0 x 18.0	1.4	PCMT 468 22105 PCMT 468 22125	PCMT 468 23105 PCMT 468 23125
1.5	7.0 x 13.5 x 18.0	1.9	PCMT 468 22155	PCMT 468 23155
1.8 2.2	8.5 x 15.0 x 18.0	2.6	PCMT 468 22185 PCMT 468 22225	PCMT 468 23185 PCMT 468 23225
2.7	10.0 x 16.5 x 18.0	3.1	PCMT 468F22275	PCMT 468F23275
3.3	11.0 x 18.5 x 18.0	4.1	PCMT 468F22335	PCMT 468F23335
Pitch = 22.5 \pm 0.4 mm			dt = 0.8 +0.08/-0.05 mm	
2.7	7.0 x 16.5 x 26.0	3.2	PCMT 468 22275	PCMT 468 23275
3.3 3.9 4.7	8.5 x 18.0 x 26.0	4.4	PCMT 468 22335 PCMT 468 22395 PCMT 468 22475	PCMT 468 23335 PCMT 468 23395 PCMT 468 23475
5.6 6.8	10.0 x 19.5 x 26.0	5.5	PCMT 468 22565 PCMT 468 22685	PCMT 468 23565 PCMT 468 23685

Metallized Polyester film capacitors

PCMT 468

 $V_{Rdc} = 250V$ $V_{Rac} = 160V\sim$

Cap. (μF)	b x h x l (mm)	Mass (g)	CATALOGUE NUMBER	
			PCMT 468	
			loose in box	
			It = 5 \pm 1 mm	
			C-tol. \pm 5 %	C-tol. \pm 10 %
Pitch = 10.0 \pm 0.4 mm			dt = 0.6 +0.06/-0.05 mm	
0.1 0.12 0.15 0.18 0.22	4.0 x 10.0 x 12.5	0.8	PCMT 468 42104 PCMT 468 42124 PCMT 468 A2154 PCMT 468 A2184 PCMT 468 A2224	PCMT 468 43104 PCMT 468 43124 PCMT 468 A3154 PCMT 468 A3184 PCMT 468 A3224
0.15 0.18 0.22 0.27 0.33	5.0 x 11.0 x 12.5	0.9	PCMT 468 42154 PCMT 468 42184 PCMT 468D42224 PCMT 468D42274 PCMT 468D42334	PCMT 468 43154 PCMT 468 43184 PCMT 468D43224 PCMT 468D43274 PCMT 468D43334
0.39 0.47	6.0 x 12.0 x 12.5	1.0	PCMT 468D42394 PCMT 468D42474	PCMT 468D43394 PCMT 468D43474
Pitch = 15.0 \pm 0.4 mm			dt = 0.8 +0.08/-0.05 mm	
0.22 0.27 0.33 0.39 0.47	5.0 x 11.0 x 18.0	1.2	PCMT 468 42224 PCMT 468 42274 PCMT 468 42334 PCMT 468 A2394 PCMT 468 A2474	PCMT 468 43224 PCMT 468 43274 PCMT 468 43334 PCMT 468 A3394 PCMT 468 A3474
0.39 0.47 0.56 0.68	6.0 x 12.0 x 18.0	1.4	PCMT 468 42394 PCMT 468 42474 PCMT 468 A2564 PCMT 468 A2684	PCMT 468 43394 PCMT 468 43474 PCMT 468 A3564 PCMT 468 A3684
0.56 0.68 0.82 1.0	7.0 x 13.5 x 18.0	1.9	PCMT 468 42564 PCMT 468 42684 PCMT 468 A2824 PCMT 468 A2105	PCMT 468 43564 PCMT 468 43684 PCMT 468 A3824 PCMT 468 A3105
0.82 1.0 1.2 1.5	8.5 x 15.0 x 18.0	2.6	PCMT 468 42824 PCMT 468 42105 PCMT 468F42125 PCMT 468F42155	PCMT 468 43824 PCMT 468 43105 PCMT 468F43125 PCMT 468F43155
1.8	10.0 x 16.5 x 18.0	3.1	PCMT 468FA2185	PCMT 468FA3185
2.2	11.0 x 18.5 x 18.0	4.1	PCMT 468FA2225	PCMT 468FA3225
Pitch = 22.5 \pm 0.4 mm			dt = 0.8 +0.08/-0.05 mm	
1.0 1.2 1.5 1.8	7.0 x 16.5 x 26.0	3.2	PCMT 468J42105 PCMT 468 42125 PCMT 468 A2155 PCMT 468 A2185	PCMT 468J43105 PCMT 468 43125 PCMT 468 A3155 PCMT 468 A3185
1.5 1.8 2.2 2.7	8.5 x 18.0 x 26.0	4.4	PCMT 468 42155 PCMT 468 42185 PCMT 468 A2225 PCMT 468 A2275	PCMT 468 43155 PCMT 468 43185 PCMT 468 A3225 PCMT 468 A3275
2.2 2.7 3.3 3.9	10.0 x 19.5 x 26.0	5.5	PCMT 468 42225 PCMT 468 42275 PCMT 468J42335 PCMT 468JA2395	PCMT 468 43225 PCMT 468 43275 PCMT 468J43335 PCMT 468JA3395
3.9 4.7 5.6	13.0 x 23.0 x 26.0	9.7	PCMT 468J42395 PCMT 468J42475 PCMT 468JA2565	PCMT 468J43395 PCMT 468J43475 PCMT 468JA3565
Pitch = 27.5 \pm 0.4 mm			dt = 0.8 +0.08/-0.05 mm	
3.3 3.9 4.7 5.6	11.0 x 21.0 x 31.0	7.8	PCMT 468 42335 PCMT 468 A2395 PCMT 468 A2475 PCMT 468 A2565	PCMT 468 43335 PCMT 468 A3395 PCMT 468 A3475 PCMT 468 A3565
3.9 4.7 5.6 6.8	13.0 x 23.0 x 31.0	10.4	PCMT 468 42395 PCMT 468 42475 PCMT 468 42565 PCMT 468 A2685	PCMT 468 43395 PCMT 468 43475 PCMT 468 43565 PCMT 468 A3685
6.8 8.2 10	15.0 x 25.0 x 31.0	12.8	PCMT 468 42685 PCMT 468 A2825 PCMT 468 A2106	PCMT 468 43685 PCMT 468 A3825 PCMT 468 A3106
12	18.0 x 28.0 x 31.0	19.6	PCMT 468 A2126	PCMT 468 A3126

Metallized Polyester film capacitors

PCMT 468

 $V_{Rdc} = 400V$ $V_{Rac} = 220V^{~~}$

mini type

Cap. (μF)	b x h x l (mm)	Mass (g)	CATALOGUE NUMBER	
			PCMT 468	
			loose in box	
			It = 5 \pm 1 mm	
		C-tol. \pm 5 %	C-tol. \pm 10 %	
Pitch = 10.0 \pm 0.4 mm			dt = 0.6 +0.06/-0.05 mm	
0.01 0.012 0.015 0.018 0.022 0.027 0.033 0.039 0.047	4.0 x 10.0 x 12.5	0.8	PCMT 468 82103 PCMT 468 82123 PCMT 468 82153 PCMT 468 82183 PCMT 468 82223 PCMT 468 82273 PCMT 468 82333 PCMT 468 82393 PCMT 468 82473	PCMT 468 83103 PCMT 468 83123 PCMT 468 83153 PCMT 468 83183 PCMT 468 83223 PCMT 468 83273 PCMT 468 83333 PCMT 468 83393 PCMT 468 83473
0.056 0.068	5.0 x 11.0 x 12.5	0.9	PCMT 468 82563 PCMT 468 82683	PCMT 468 83563 PCMT 468 83683
0.082 0.1	6.0 x 12.0 x 12.5	1.0	PCMT 468 82823 PCMT 468 82104	PCMT 468 83823 PCMT 468 83104
Pitch = 15.0 \pm 0.4 mm			dt = 0.8 +0.08/-0.05 mm	
0.1 0.12 0.15	5.0 x 11.0 x 18.0	1.2	PCMT 468 52104 PCMT 468 82124 PCMT 468 82154	PCMT 456 53104 PCMT 468 83124 PCMT 468 83154
0.15 0.18 0.20 0.22	6.0 x 12.0 x 18.0	1.4	PCMT 468 52154 PCMT 468 82184 PCMT 468 82204 PCMT 468 82224	PCMT 468 53154 PCMT 468 83184 PCMT 468 83204 PCMT 468 83224
0.22 0.27 0.33	7.0 x 13.5 x 18.0	1.9	PCMT 468 52224 PCMT 468 82274 PCMT 468 82334	PCMT 468 53224 PCMT 468 83274 PCMT 468 83334
0.33 0.39 0.47	8.5 x 15.0 x 18.0	2.6	PCMT 468 52334 PCMT 468 82394 PCMT 468 82474	PCMT 468 53334 PCMT 468 83394 PCMT 468 83474
0.56	10.0 x 16.5 x 18.0		PCMT 468 82564	PCMT 468 83564
Pitch = 22.5 \pm 0.4 mm			dt = 0.8 +0.08/-0.05 mm	
0.47	7.0 x 16.5 x 26.0	3.2	PCMT 468 52474	PCMT 468 53474
0.68 0.82	8.5 x 18.0 x 26.0	4.4	PCMT 468 82684 PCMT 468 82824	PCMT 468 83684 PCMT 468 83824
1.0 1.2	10.0 x 19.5 x 26.0	5.5	PCMT 468 82105 PCMT 468 82125	PCMT 468 83105 PCMT 468 83125
Pitch = 27.5 \pm 0.4 mm			dt = 0.8 +0.08/-0.05 mm	
1.2 1.5 1.8	11.0 x 21.0 x 31.0	7.8	PCMT 468 52125 PCMT 468 82155 PCMT 468 82185	PCMT 468 53125 PCMT 468 83155 PCMT 468 83185
2.2 2.7	13.0 x 23.0 x 31.0	12.8	PCMT 468 82225 PCMT 468 82275	PCMT 468 83225 PCMT 468 83275
3.3 3.9	15.0 x 25.0 x 31.0	17.2	PCMT 468 82335 PCMT 468 82395	PCMT 468 83335 PCMT 468 83395
4.7	18.0 x 28.0 x 31.0	19.6	PCMT 468 82475	PCMT 468 83475

■ ; Larger type

Metallized Polyester film capacitors

PCMT 468

 $V_{Rdc} = 630V$ $V_{Rac} = 250V\sim$

Cap. (μF)	b x h x l (mm)	Mass (g)	CATALOGUE NUMBER	
			PCMT 468	
			loose in box	
			It = 5 \pm 1 mm	
			C-tol. \pm 5 %	C-tol. \pm 10 %
Pitch = 10.0 \pm 0.4 mm			dt = 0.6 +0.06/-0.05 mm	
0.01 0.012	4.0 x 10.0 x 12.5	0.8	PCMT 468 62103 PCMT 468 62123	PCMT 468 63103 PCMT 468 63123
0.015 0.018 0.022 0.027 0.033 0.039 0.047	5.0 x 11.0 x 12.5	0.9	PCMT 468 62153 PCMT 468 62183 PCMT 468 62223 PCMT 468 62273 PCMT 468 62333 PCMT 468 Q2393 PCMT 468DQ2473	PCMT 468 63153 PCMT 468 63183 PCMT 468 63223 PCMT 468 63273 PCMT 468 63333 PCMT 468 Q3393 PCMT 468DQ3473
0.039 0.047 0.056 0.068	6.0 x 12.0 x 12.5	1.0	PCMT 468 62393 PCMT 468 62473 PCMT 468DQ2563 PCMT 468DQ2683	PCMT 468 63393 PCMT 468 63473 PCMT 468DQ3563 PCMT 468DQ3683
Pitch = 15.0 \pm 0.4 mm			dt = 0.8 +0.08/-0.05 mm	
0.047 0.056 0.068	5.0 x 11.0 x 18.0	1.2	PCMT 468F62473 PCMT 468 62563 PCMT 468 Q2683	PCMT 468F63473 PCMT 468 63563 PCMT 468 Q3683
0.068 0.082 0.1	6.0 x 12.0 x 18.0	1.4	PCMT 468 62683 PCMT 468 62823 PCMT 468 Q2104	PCMT 468 63683 PCMT 468 63823 PCMT 468 Q3104
0.1 0.12 0.15	7.0 x 13.5 x 18.0	1.9	PCMT 468 62104 PCMT 468 62124 PCMT 468 Q2154	PCMT 468 63104 PCMT 468 63124 PCMT 468 Q3154
0.15 0.18	8.5 x 15.0 x 18.0	2.6	PCMT 468 62154 PCMT 468 62184	PCMT 468 63154 PCMT 468 63184
0.22 0.27	10.0 x 16.5 x 18.0	3.1	PCMT 468F62224 PCMT 468FQ2274	PCMT 468F63224 PCMT 468FQ3274
0.33 0.39	11.0 x 18.5 x 18.0	4.1	PCMT 468FQ2334 PCMT 468FQ2394	PCMT 468FQ3334 PCMT 468FQ3394
Pitch = 22.5 \pm 0.4 mm			dt = 0.8 +0.08/-0.05 mm	
0.22 0.27	7.0 x 16.5 x 26.0	3.2	PCMT 468 62224 PCMT 468 62274	PCMT 468 63224 PCMT 468 63274
0.33 0.39	8.5 x 18.0 x 26.0	4.4	PCMT 468 62334 PCMT 468 62394	PCMT 468 63334 PCMT 468 63394
0.47 0.56	10.0 x 19.5 x 26.0	5.5	PCMT 468 62474 PCMT 468 62564	PCMT 468 63474 PCMT 468 63564
0.68 0.82 1.0	13.0 x 23.0 x 26.0	9.7	PCMT 468JQ2684 PCMT 468JQ2824 PCMT 468JQ2105	PCMT 468JQ3684 PCMT 468JQ3824 PCMT 468JQ3105
Pitch = 27.5 \pm 0.4 mm			dt = 0.8 +0.08/-0.05 mm	
0.68 0.82	11.0 x 21.0 x 31.0	7.8	PCMT 468 62684 PCMT 468 Q2824	PCMT 468 63684 PCMT 468 Q3824
0.82 1.0	13.0 x 23.0 x 31.0	10.4	PCMT 468 62824 PCMT 468 Q2105	PCMT 468 63824 PCMT 468 Q3105
1.0 1.2 1.5	15.0 x 25.0 x 31.0	12.8	PCMT 468 62105 PCMT 468 Q2125 PCMT 468 Q2155	PCMT 468 63105 PCMT 468 Q3125 PCMT 468 Q3155
1.2 1.8 2.2	18.0 x 28.0 x 31.0	17.2	PCMT 468 62125 PCMT 468 Q2185 PCMT 468 Q2225	PCMT 468 63125 PCMT 468 Q3185 PCMT 468 Q3225

MOUNTING
NORMAL USE

The capacitors are designed for mounting on printed-circuit boards. The capacitors packed in bandoliers are designed for mounting on printed-circuit boards by means of automatic insertion machines.

SPECIFIC METHOD OF MOUNTING OF WITHSTAND VIBRATION AND SHOCK.

In order to withstand vibration and shock tests, it must be ensured that the stand-off pips are in good contact with the printed-circuit boards.

- . For l_{max} 18mm the capacitors shall be mechanically fixed by the leads.
- . For larger pitches the capacitors shall be mounted in the same way and the body clamped.

SPACE REQUIREMENTS ON PRINTED-CIRCUIT BOARD

The maximum length and width of film capacitors are shown in the following drawing ;

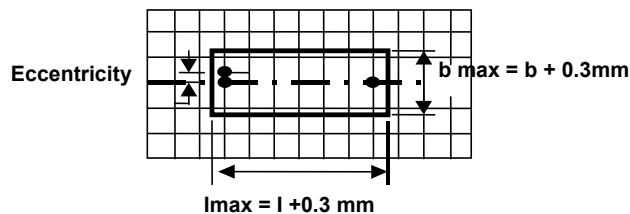

- Eccentricity as in drawing.

The maximum eccentricity is smaller than or equal to the lead diameter of the product concerned.

- Product height with seating plane as given by IEC 60717 as reference : $h_{max} \leq h + 0.3mm$

Metallized Polyester film capacitors

PCMT 468

STORAGE TEMPERATURE

. Storage temperature : $T_{stg} = -25$ to $+40^{\circ}\text{C}$ with RH maximum 80% without condensation.

RATINGS AND CHARACTERISTICS

Unless otherwise specified, all electrical values apply at an ambient free air temperature of $23 \pm 1^{\circ}\text{C}$, an atmospheric pressure of 86 to 106 kPa and a relative humidity of $50 \pm 2\%$.

For reference testing, a conditioning period shall be applied over 96 ± 4 hours by heating the products in a circulating air oven at the rated temperature and a relative humidity not exceeding 20%.

CHARACTERISTICS

● Test Voltage

- . Test Voltage (between leads) : $1.6 \times V_{Rdc}$, 1 min (cut off current 10mA, rise time 100V/s)
- . Test Voltage (between leads and case) : $2.0 \times V_{Rdc}$, 1 min

● Dissipation Factor

Rated voltage	Capacitance	Tangent of loss angle ($\times 10^{-4}$)	
		1 KHz	10 KHz
100 V	$0.27 \mu\text{F} < C \leq 1.0 \mu\text{F}$	≤ 75	≤ 130
	$1.0 \mu\text{F} < C \leq 6.8 \mu\text{F}$	≤ 75	≤ 150
250 V	$0.1 \mu\text{F} < C \leq 0.1 \mu\text{F}$	≤ 75	≤ 130
	$1.0 \mu\text{F} < C \leq 12 \mu\text{F}$	≤ 75	≤ 150
400 V	$0.1 \mu\text{F} < C \leq 0.1 \mu\text{F}$	≤ 75	≤ 130
	$1.0 \mu\text{F} < C \leq 4.7 \mu\text{F}$	≤ 75	≤ 150
630 V	$0.1 \mu\text{F} < C \leq 0.1 \mu\text{F}$	≤ 75	≤ 130
	$1.0 \mu\text{F} < C \leq 2.2 \mu\text{F}$	≤ 75	≤ 150

● Insulation Resistance

The insulation resistance is measured after a voltage has been applied for 1 minute ± 5 seconds, the voltage being $100 \pm 15\text{V}$ for the 100, 250 and 400V versions and $500 \pm 50\text{V}$ for the 630V versions.

Rated voltage	Capacitance	R between leads ($M\Omega$)	RC between leads (sec)
100 V	$C > 0.33 \mu\text{F}$	-	$> 5\ 000$ s
250 V / 400 V / 630 V	$C \leq 0.33 \mu\text{F}$	$> 30\ 000$	-
	$C > 0.33 \mu\text{F}$	-	$> 10\ 000$ s

● Rated Voltage Pulse Load Slope (dV/dt)_R

For values see specific reference data. If the pulse voltage is lower than the rated voltage, the values of the specific reference data must be multiplied by V_{Rdc} and divided by the applied voltage.

Rated voltage	Rated pulse load(V/ μs) as a function of I_{max}			
	$I_{max} = 12.5\text{mm}$	$I_{max} = 18.0\text{mm}$	$I_{max} = 26.0\text{mm}$	$I_{max} = 31.0\text{mm}$
100 V	30	20	20	-
250 V	120	45	20	15
400 V	170	65	30	25
630 V	120	90	35	30

THE GRAPHS OF CHARACTERISTICS

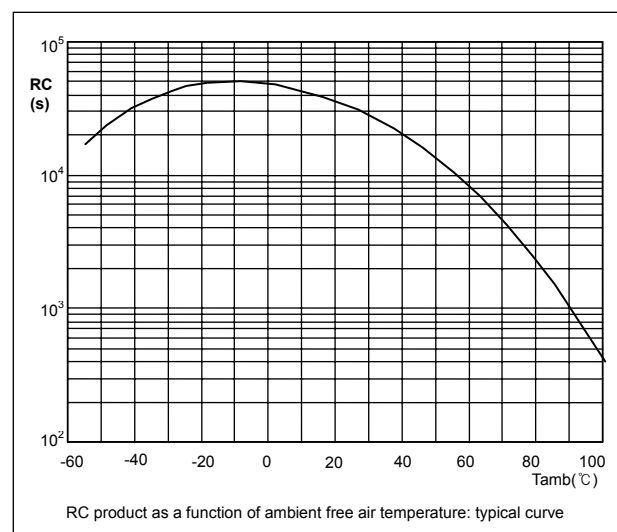
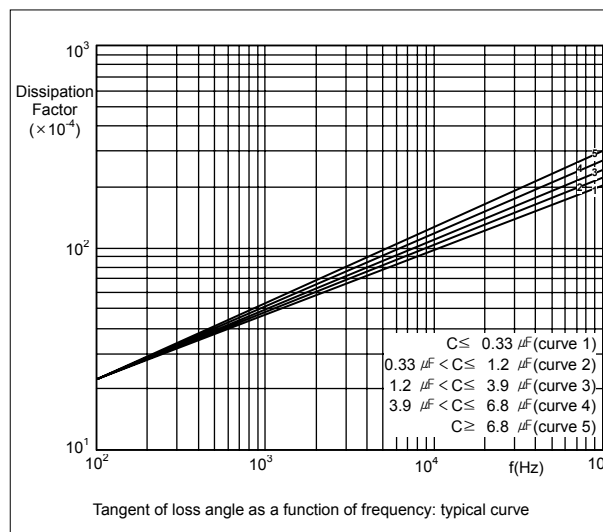
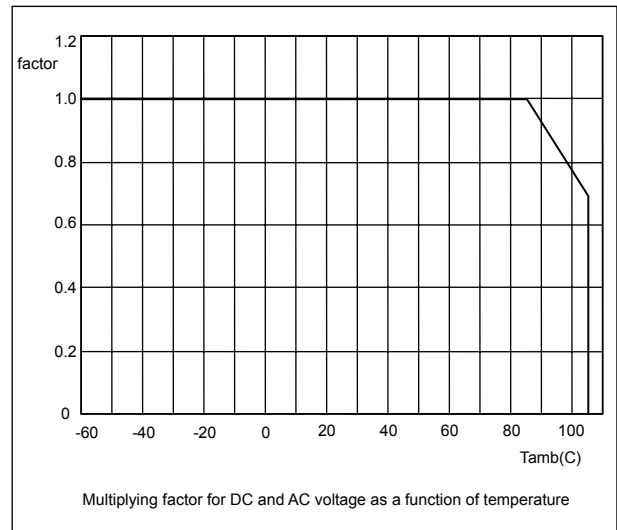
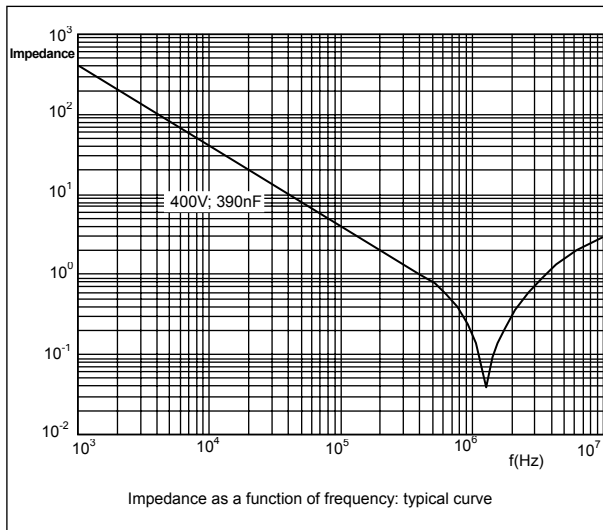
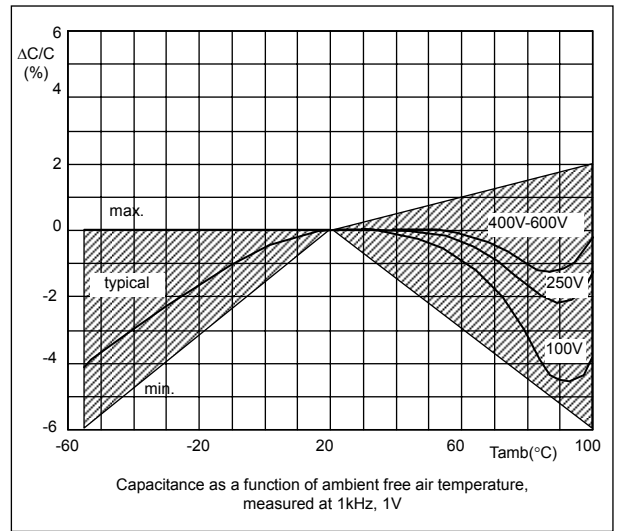
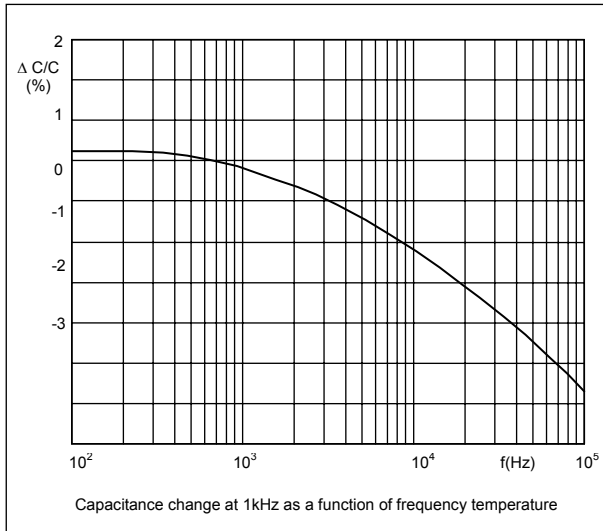

MAXIMUM RMS VOLTAGE (SINEWAVE) AS A FUNCTION OF FREQUENCY

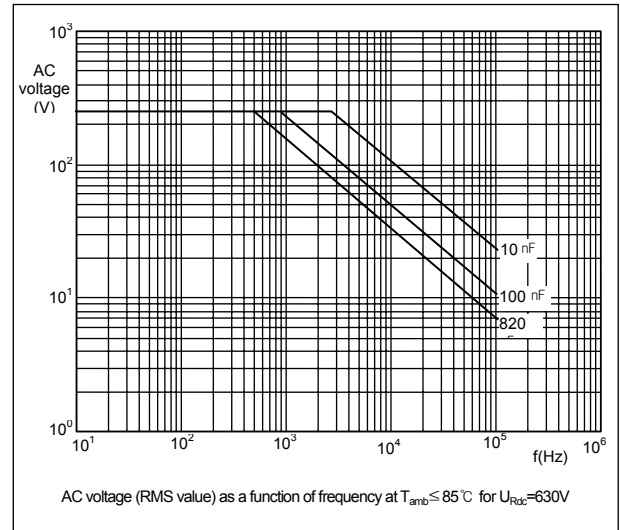
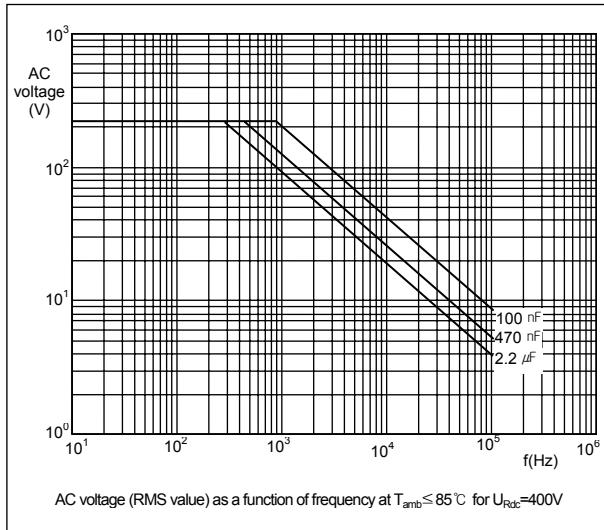
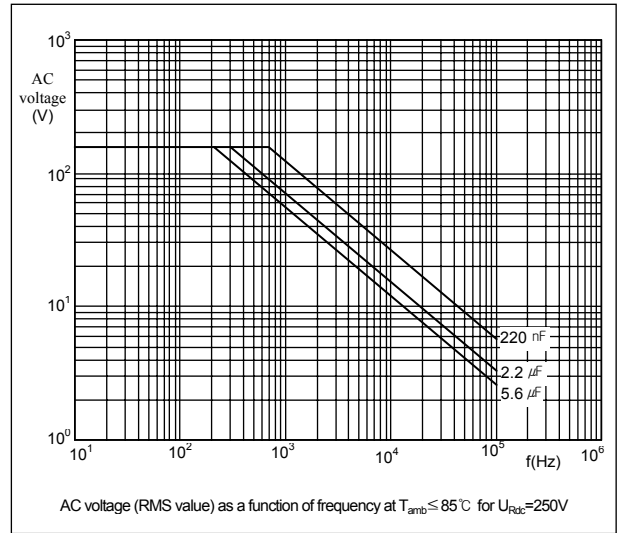
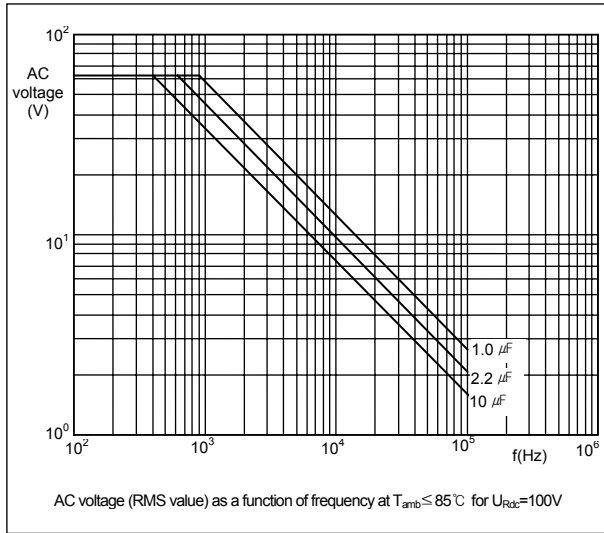

APPLICATION NOTE AND LIMITING CONDITIONS

These capacitors are not suitable for mains application as across-the-line capacitors without additional protection.

To select the capacitor for a certain application, the following conditions must be checked :

1. The peak voltage (V_p) shall not be greater than the rated DC voltage (V_{Rdc}).
2. The peak-to-peak voltage (V_{p-p}) shall not be greater than the maximum V_{p-p} to avoid the ionization inception level.
3. The voltage pulse slope (dV/dt) shall not exceed the rated voltage pulse slope in an RC-circuit at rated voltage and without ringing. If the pulse voltage is lower than the rated DC voltage, the rated voltage pulse slope may be multiplied by V_{Rdc} and divided by the applied voltage.

For all other pulses following equation must be fulfilled :

$$2 \times \int_0^T \left(\frac{dU}{dt} \right)^2 \times dt < U_{Rdc} \times \left(\frac{dU}{dt} \right)_{rated}$$

T is the pulse duration.

4. The maximum component surface temperature rise must be lower than the limits.

Voltage conditions for aboves.

ALLOWED VOLTAGES	$T_{amb} \leq 85^\circ\text{C}$	$85^\circ\text{C} < T_{amb} \leq 105^\circ\text{C}$
Maximum continuous RMS voltage	V_{Rac}	$0.7 \times V_{Rac}$
Maximum temporary RMS over voltage (<24 hrs)	$1.25 \times V_{Rac}$	$0.875 \times V_{Rac}$

PRODUCT MARKING

The capacitors are marked on the top and side or on the top with the following information ;

- . Rated capacitance in code according to IEC 60062
- . Tolerance on rated capacitance : J = $\pm 5\%$, K = $\pm 10\%$
- . Rated DC voltage : (e.g. 400V)
- . Manufacturer's type designation : (468)
- . Code for dielectric material : (MKT(ME))

Example of marking

pitch = 10mm

100n J 630V 468 MKT PILKOR

Marking on the side

pitch = 15mm

100n J 630V 468 MKT(ME)

Marking on the top

PILKOR WK....

Marking on the side

pitch = 22.5mm / 27.5mm

470n J 400V PILKOR 468 MKT(ME) WK....
--

Marking on the top

470n J 400V 468 MKT(ME)

Marking on the top

PILKOR WK....

Marking on the side

pitch = 27.5mm

4u7 J 400V 468 MKT PILKOR

Marking on the top

Metallized Polyester film capacitors

PCMT 468

PACKAGE MARKING

The package containing the capacitors is marked as shown.

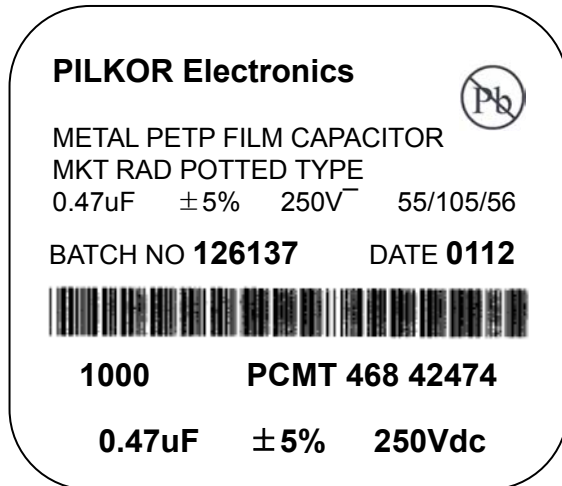

LINE MARKING EXPLANAION

- 1 Manufacturer's name
- 2 Sub-family
3. Pb free marking(JEDEC-STD-97)
- 4 Type description
- 5 Capacitance value, tolerance, voltage and climatic category (IEC)
- 6 Batch number & production period year and week code
- 7 Quantity and Product code (12NC)
- 8 Capacitance, tolerance and voltage

PACKING

DIMENSIONS OF TAPED PRODUCTS (reel & ammo packing)

- **Capacitors with terminal pitch = 10.0mm**
(hole to hole ; $P_0=12.7\text{mm}$ or 15.0mm)

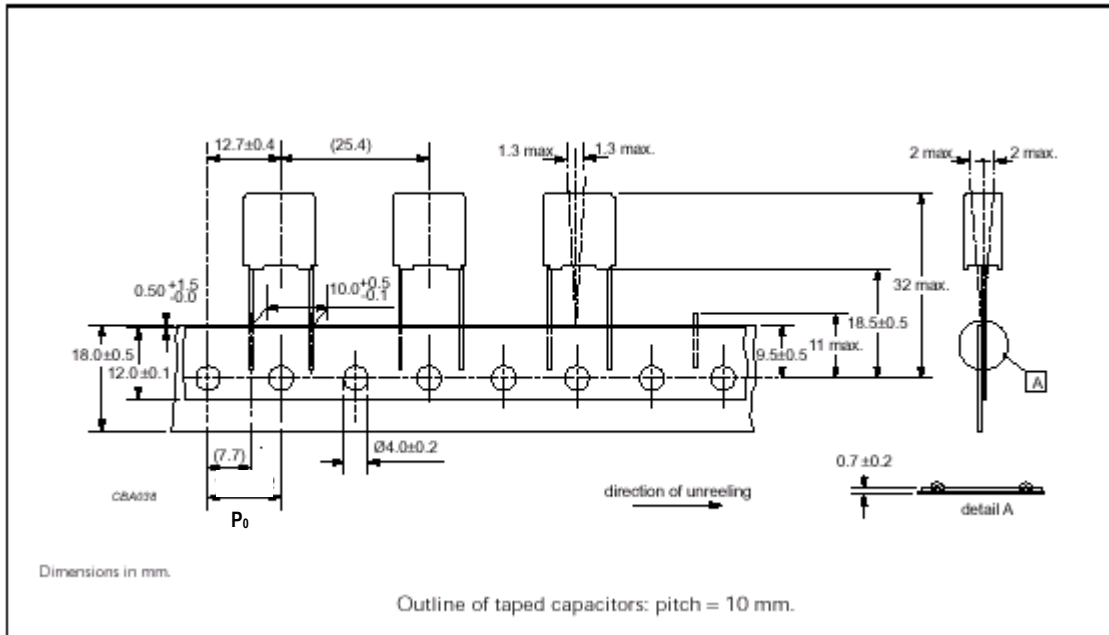

- **Capacitors with terminal pitch = 15.0mm**
(hole to hole ; $P_0=12.7\text{mm}$ or 15.0mm)

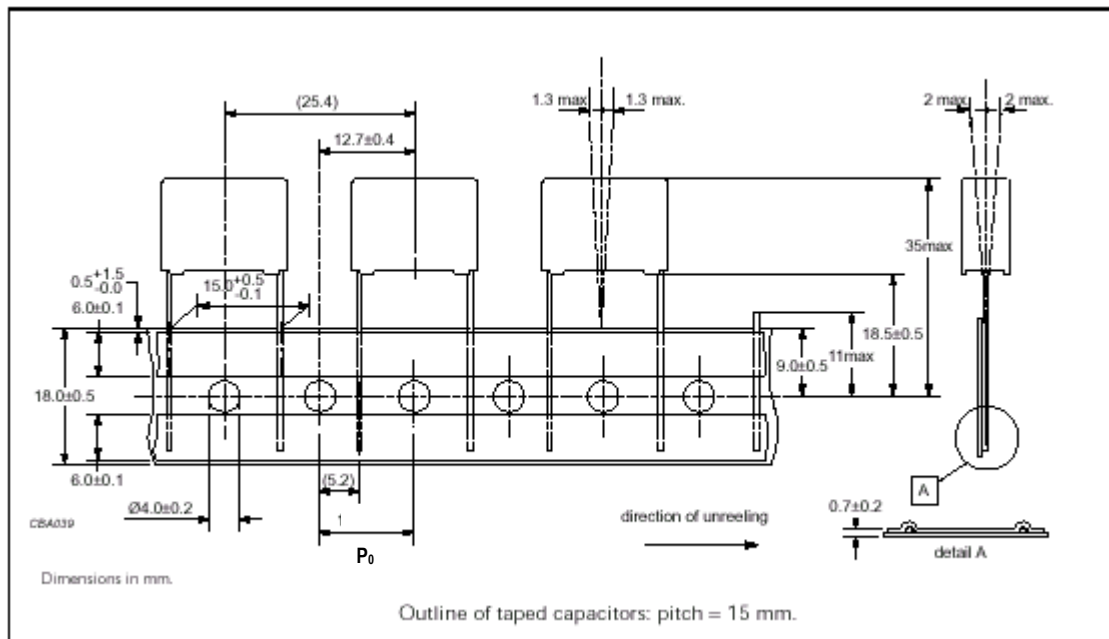

Metallized Polyester film capacitors

- **Capacitors with terminal pitch = 22.5mm**
(hole to hole ; $P_0=12.7\text{mm}$ or 15.0mm)

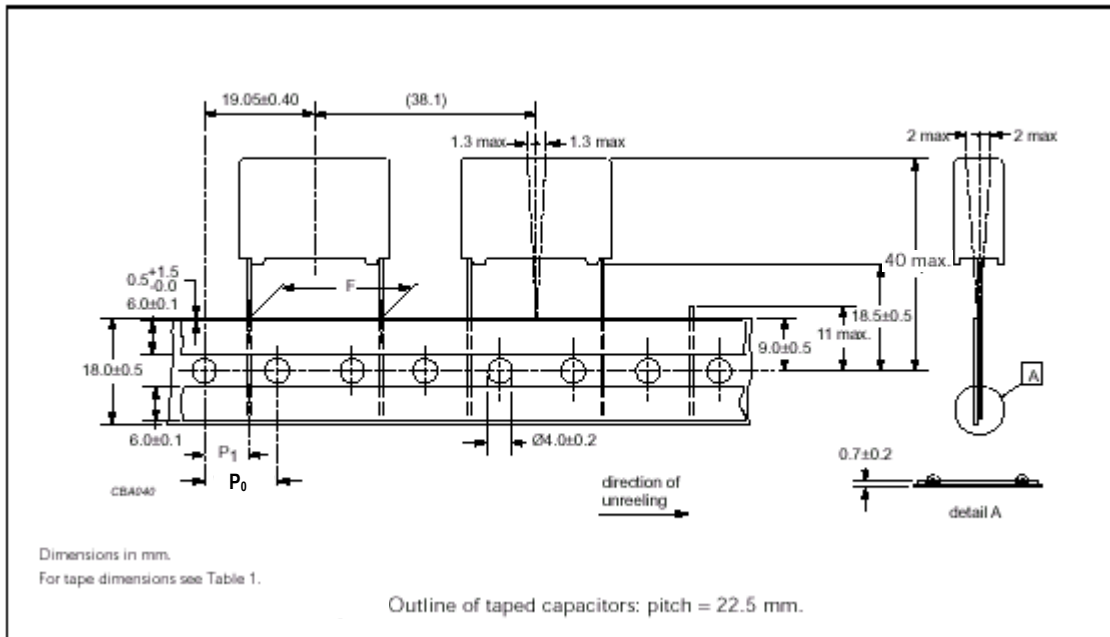

- **Capacitors with original terminal pitch = 15.0mm (reduced pitch = 7.5mm)**
(hole to hole ; $P_0= 15.0\text{mm}$)

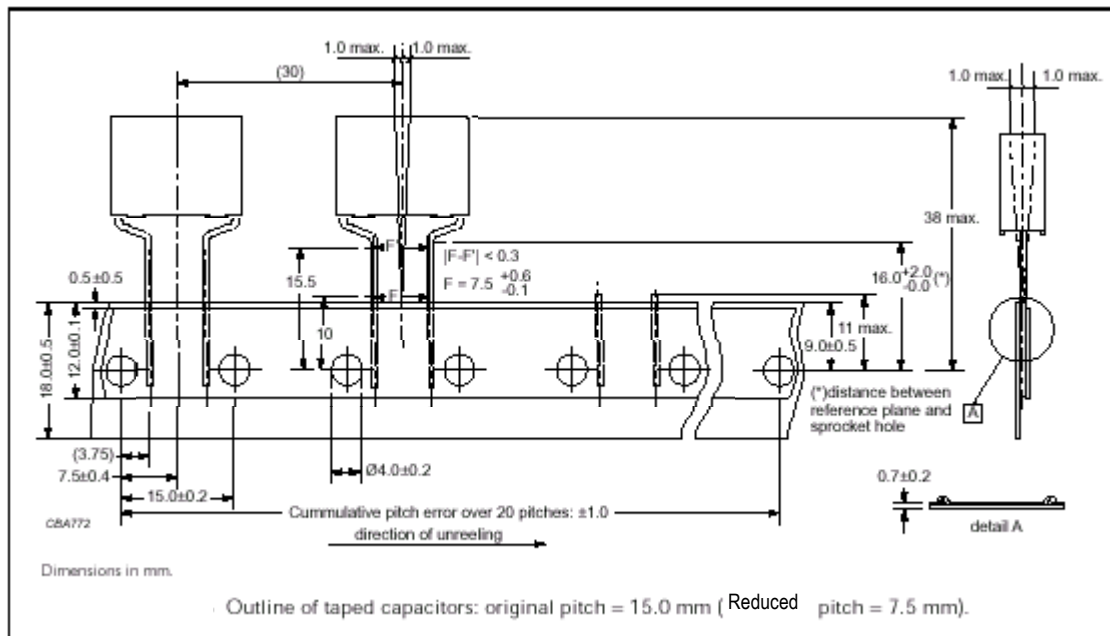

TEST REQUIREMENTS

TEST	D or ND	CONDITIONS	p	n	REQUIREMENTS
Group A inspection (periodic)					
Sub-group A1, A2	ND				
4.1 Dimensions (detail)					As specified in Table 1 of this specification
4.2.2 capacitance		at 1 kHz			Within specified tolerance
4.2.3 Tangent of loss angle		at 10 kHz			As in this specification
4.2.1 Voltage proof (test A)		at $1.6 \times V_{Rdc}$ for 1 min or $1.75 \times V_{Rdc}$ for 5 s			No breakdown or flashover. (cut-off current 10mA)
4.2.5 Insulation resistance (test A)		at 100V for $V_{Rdc} < 630V$ at 500V for $V_{Rdc} \geq 630V$			As in this specification
Group C inspection (periodic)					
Sub-group C1A part of a sample of sub-group C1	D		6	9	
4.3 Robustness of terminals		Tensile & bending			No visible damage, Legible marking $\Delta C/C \leq 2\%$ $\Delta \tan \delta < 0.0050$
4.4 Resistance to soldering heat		Solder bath : 260°C ; 10 s			
4.14 Component solvent resistance		Isopropyl alcohol ; 23°C ; 5 min			
Sub-group C1B Other part of sample of sub-group C1	D		6	18	
4.6 Rapid change of temperature		θA = lower category temperature θB = upper category temperature 5 cycles Duration $t = 30$ min			No visible damage $\Delta C/C \leq 5\%$
4.7 Vibration (see note 4)		10Hz to 55Hz Amplitude : 0.75mm or acceleration $98m/s^2$ 6hrs			$\Delta \tan \delta < 0.0050$
4.9 Shock (see note 4)		Half sine wave ; $490m/s^2$: 11 ms			$R_{ins} \geq 50\%$ specified value

TEST	D or ND	CONDITIONS	p	n	REQUIREMENTS
Sub-group C1 Combined of sample of specimens of sub-groups C1A and C1B	D		6	27	
4.10 Climatic sequence 4.10.2 Dry heat 4.10.3 Damp heat cyclic, test Db, first cycle 4.10.4 Cold 4.10.6 Damp heat cyclic, test Db, remaining cycle		T = T _{upp-cat} , 16 hours T = T _{low-cat} , 2 hours			No visible damage, Legible marking $\Delta C/C \leq 5\%$ $\Delta \tan \delta < 0.0080$ $R_{ins} \geq 50\%$ specified value
Sub-group C2	D		6	15	
4.11 Damp heat steady state		56days ; 40 °C ; 90 to 95%RH			No visible damage, Legible marking $\Delta C/C \leq 5\%$ $\Delta \tan \delta < 0.0050$ $R_{ins} \geq 50\%$ specified value
Sub-group C3	D		3	21	
4.12 Endurance (DC)		1000hours ; 85 °C ; 1.25 x V _{Rdc} 105 °C ; 0.9375 x V _{Rdc}			No visible damage, Legible marking $\Delta C/C \leq 8\%$ $\Delta \tan \delta < 0.0050$ $R_{ins} \geq 50\%$ specified value
Sub-group C4	D		3	9	
4.13 Charge and discharge		Number of pulse; 10000 Pulse frequency ; (1Hz) Test pulse rise ; 2.5 x C(dV/dt) _R			$\Delta C/C \leq 5\%$ $\Delta \tan \delta < 0.0050$ $R_{ins} \geq 50\%$ specified value

TEST	D or ND	CONDITIONS	p	n	REQUIREMENTS
Sub-group ADD1	D		3	35	
A.1 Solderability		Non-activated colophony flux 501 Solder bath : 245°C Dwell time : 3s			Good tinning as evidenced by free flowing of the solder with wetting of the terminations (>95%)
Solvent resistance of the marking		Isopropyl alcohol at 23°C Rubbing material ; cotton wool immersion time : 5 ± 0.5 min			Legible marking
Sub-group ADD2	D		3	12	
A.2 Heat storage		2000 hrs Upper category temperature			$\Delta C/C \leq 3\%$ $\Delta \tan \delta < 0.0050$ $R_{ins} \geq 50\%$ specified value
Sub-group ADD3					
A.3 Endurance(AC) ac volt. > 200 (r.m.s)		Duration : 1000 hours Temp. : 85 °C For 250V, 400V : 1.25 x V _{RMS} , 50Hz For 630V : 1.1 x V _{RMS} , 50Hz			$\Delta C/C \leq 10\%$ $\Delta \tan \delta < 0.0050$ $R_{ins} \geq 50\%$ specified value
Sub-group ADD4			3	9	
A.4 Detergent resistance		Density 20g/L dishwasher detergent 70°C, 3min followed by rinsing in clear water for 1 minute. Recovery time 1 to 2 hours.			$\Delta C/C \leq 1\%$ $\Delta \tan \delta < 0.0050$ $R_{ins} \geq 50\%$ specified value
Sub-group ADD5	D		6	15	
A.5 Resistance to soldering heat with preheating		Capacitors mounted on a 1.6mm board with non-plated holes Body temp. : 80 °C Bath temp. : 260 °C Dwell time : 10 s.			$\Delta C/C \leq 2\%$ for C ≤ 10nF $\Delta C/C \leq 1\%$ for C > 10nF $\Delta \tan \delta < 0.0050$ $R_{ins} \geq 50\%$ specified value
Sub-group ADD6			3	15	
A.6 climatic test on taped type		10 days; 40°C; 90 to 95% RH			Angle component ≤ 4 ° Pull out and tearing force ≥ 50% of specified value

Metallized Polyester film capacitors

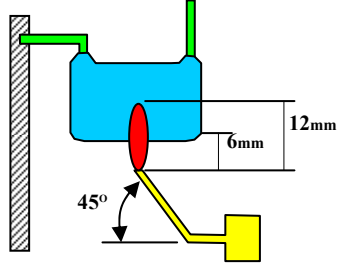
TEST	D or ND	CONDITIONS	p	n	REQUIREMENTS								
Sub-group ADD7			12	18									
A.7 Passive flammability		<p>IEC 60384-1 Bore of gas jet : ϕ 0.5 mm Fuel : Butane Test duration for actual volume V in mm³</p> <p>class B</p> <table border="1"> <thead> <tr> <th>Volume(mm³)</th> <th>Gas jet</th> </tr> </thead> <tbody> <tr> <td>250 < V ≤ 500</td> <td>20s</td> </tr> <tr> <td>500 < V ≤ 1750</td> <td>30s</td> </tr> <tr> <td>V > 1750</td> <td>60s</td> </tr> </tbody> </table> <p>One flame application</p> 	Volume(mm ³)	Gas jet	250 < V ≤ 500	20s	500 < V ≤ 1750	30s	V > 1750	60s			<p>1.class B After removing test flame from capacitor, the capacitor must not continue burn for more than 10 s.</p> <p>2.No burning particle must drop from the sample</p>
Volume(mm ³)	Gas jet												
250 < V ≤ 500	20s												
500 < V ≤ 1750	30s												
V > 1750	60s												
Sub-group ADD8	D		12	10									
A.8 Thermal Shock		<p>θA = lower category temperature θB = upper category temperature 100 cycles Duration t = 30 min</p>			<p>$\Delta C/C \leq 10\%$ $\Delta \tan\delta(1\text{KHz}) < 0.01$ $R_{\text{ins}} \geq 50\%$ specified value</p>								



CONSTRUCTION

- Product type ; Metallized PET film capacitors
- Model name ; PCMT 468 XXXXX

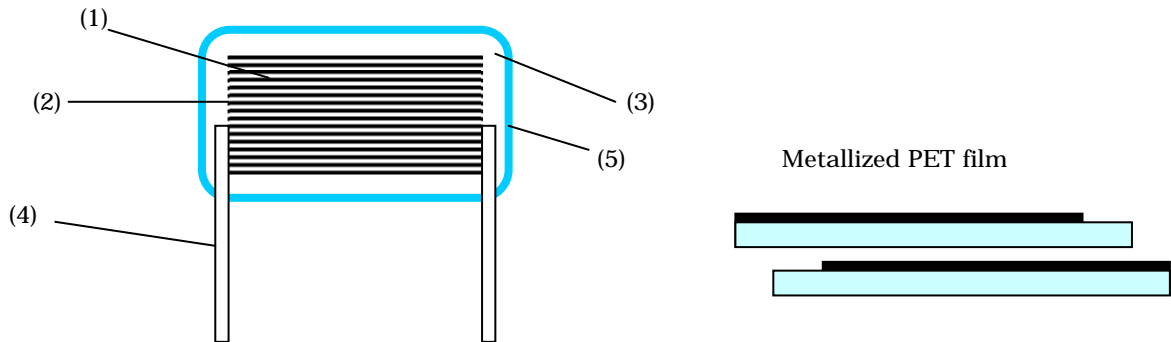

	Description	Material
1	M-PET	Metallized PET film
2	Metal Spray	Tin-Zinc
3	Epoxy	UL94V-0
4	Lead Wire	Tin plated Copper wire 0.6/0.8mm [Sn 100% :10 μ m]
5	PP Case	POLYPROPYLENE UL94-V0

PILKOR ELECTRONICS CO., LTD